

PCB4D-C-1030 BBO Pockels cell with two BBO crystals

Crystal size: 4x4x20 mm

Clear aperture: diameter 3.5 mm

Quarter wave voltage at 1030 nm: < 2.3 kV DC

Capacitance: 6 pF

Optical transmission: > 98 % at 1030 nm

Contrast ratio in crossed polarizers (ICR): > 1:500 (no voltage is applied)

Damage threshold of AR coatings: > 0.5 GW/cm² (5 J/cm²), 1064 nm, 10 Hz, 10 ns

With ceramic apertures and protective windows on both ends

Cell size: diameter 25.4 mm x 57.2 mm (L)

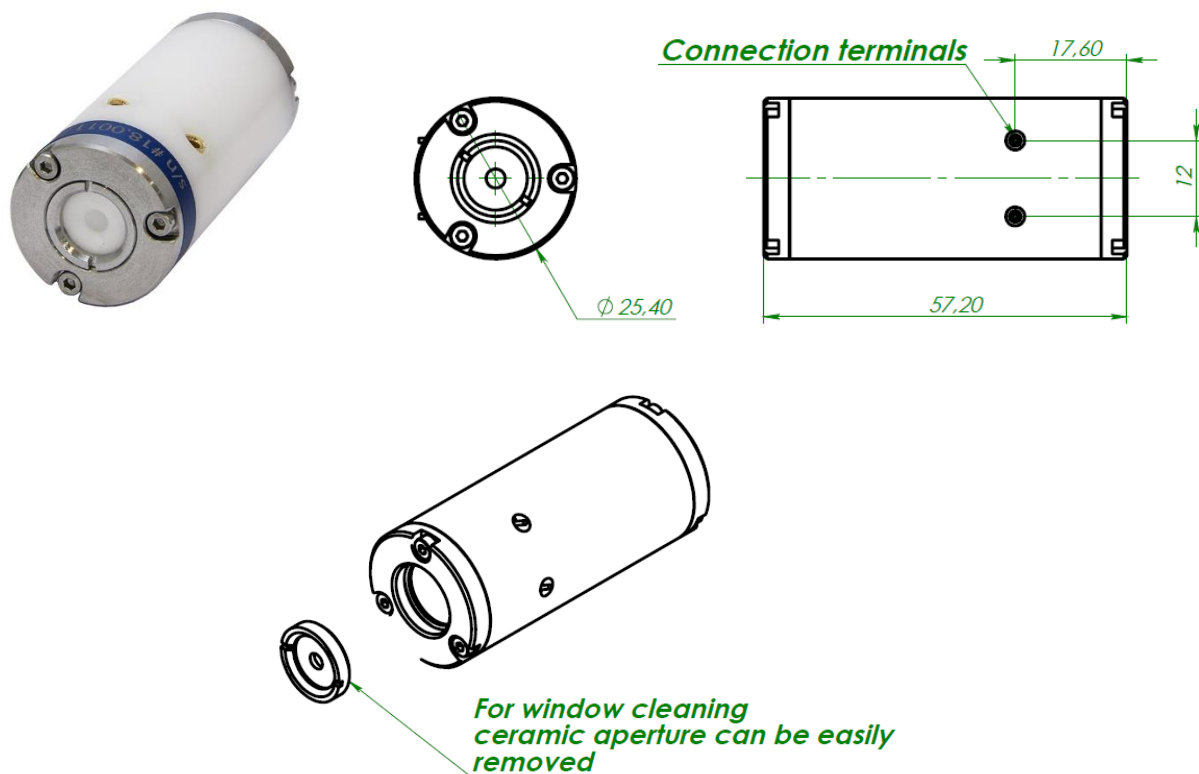

Outline picture and drawing of **PCB4D** BBO Pockels cell

The specifications are subject to change without any notice in advance.