

**PCB3D-C-800** BBO Pockels cell with two BBO crystals

Crystal size: 3x3x20 mm

Clear aperture: diameter 2.5 mm

Quarter wave voltage at 800 nm: < 1.3 kV DC

Capacitance: < 6 pF

Optical transmission: > 98 % at 800 nm

Contrast ratio in crossed polarizers (ICR): > 1:500 (no voltage is applied)

Damage threshold of dielectric AR coatings: > 0.5 GW/cm<sup>2</sup>, 1064 nm, 10 Hz, 10 ns

With ceramic apertures on both ends

Cell size: diameter 25.4 mm x 57.2 mm (L)

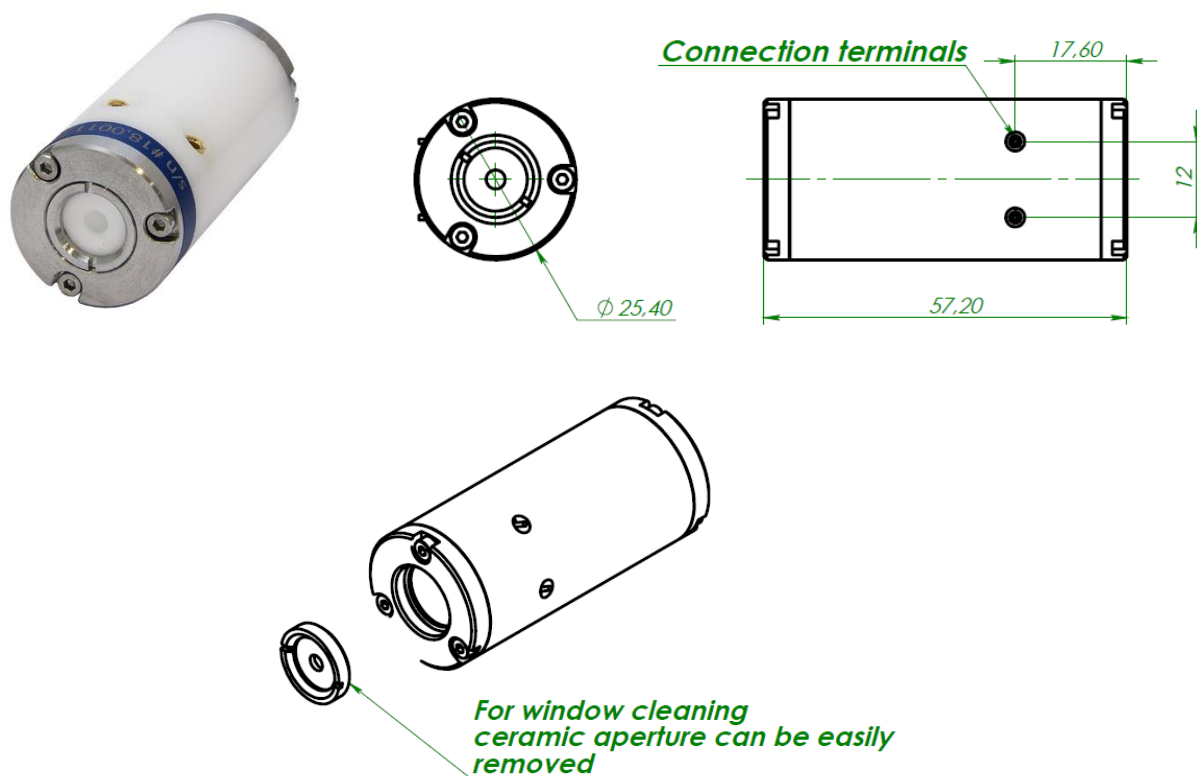

Outline picture and drawing of **PCB3D** BBO Pockels cell

The specifications are subject to change without any notice in advance.