

NOTES:

1. Material: sapphire, orientation c-cut [111];
2. G - Fine ground surface;
3. TWD: $<1 \lambda @ 633 \text{ nm}$;
4. Parallelism: $<3 \text{ arcmin}$;
5. All dimensions are in mm.

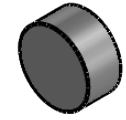

Isometric view 1:1

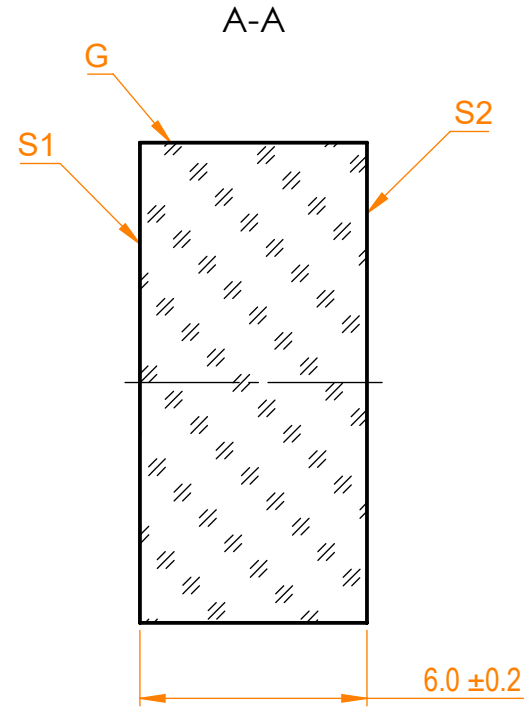
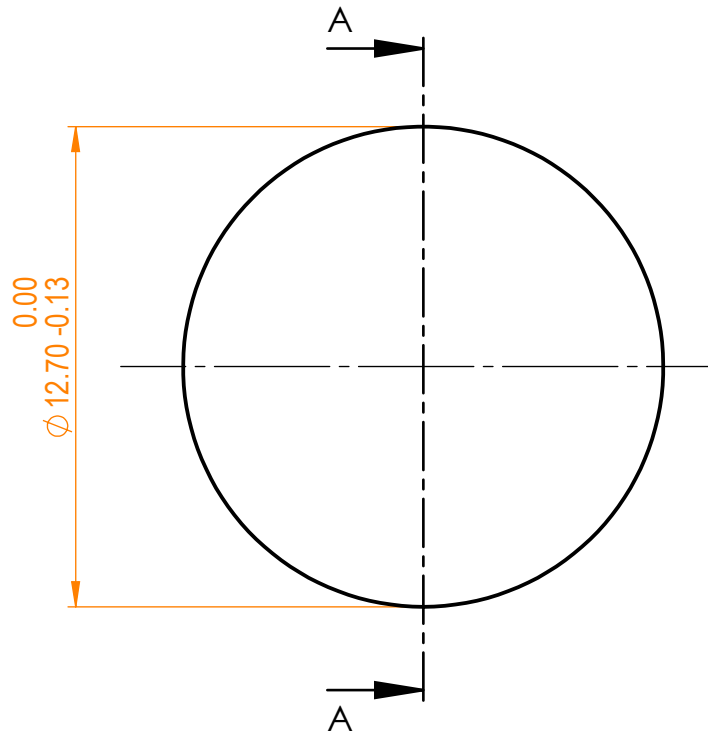

Specifications are subject to change without notice
Dimensions are for reference only

Parameters

	S1	S2
Shape	Plano	Plano
Surface quality	60-40 s/d	60-40 s/d
Surface flatness	-	-
Protective chamfers	0.2 - 0.3 mm x 45°	0.2 - 0.3 mm x 45°
Clear aperture	≥90%	≥90%
Coating	-	-



Sapphire pl window, D=12.7 mm

Proprietary		Name	Date	Part number	Rev.	Scale
The information in this drawing is property of EKSMA Optics. Any reproduction in part or as a whole without the written permission of EKSMA Optics is prohibited.	Approved	A.K.	2021.02.01	550-7126	A	5:1
	Drawn	M.B.	2021.02.01			