

- NOTES:
 1. Material: single crystal CaF₂, orientation [001];
 2. G - Fine ground surface;
 3. TWD: $\lambda/4$ @ 633 nm;
 4. Parallelism: <1 arcmin;
 5. All dimensions are in mm.

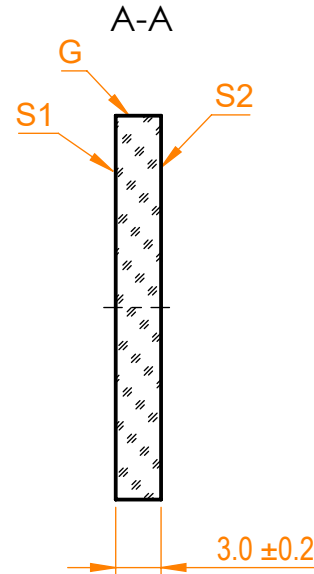

Isometric view 1:2

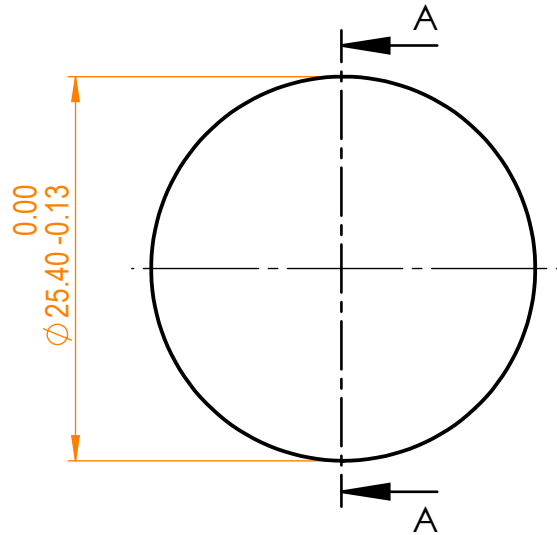

Specifications are subject to change without notice
 Dimensions are for reference only

	Parameters	
	S1	S2
Shape	Plano	Plano
Surface quality	40-20 s/d	40-20 s/d
Surface flatness	-	-
Protective chamfers	0.2 - 0.3 mm x 45°	0.2 - 0.3 mm x 45°
Clear aperture	≥90%	≥90%
Coating	-	-



CaF₂ pl window, D=25.4 mm

Proprietary	Name	Date	Part number	Rev.	Scale
The information in this drawing is property of EKSMA Optics. Any reproduction in part or as a whole without the written permission of EKSMA Optics is prohibited.	Approved	A.K.	2021.02.01	531-5253	A
	Drawn	M.B.	2021.02.01		