

NOTES:

1. Material: N-SF2;
2. G - Fine ground surface;
3. All dimensions are in mm;
4. Protective chamfers: 0.3 mm x 45°;
5. Beam deviation: <3 arcmin;
6. Typical damage threshold: >1 J/cm² at @532nm;

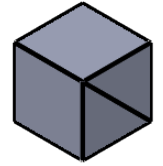

Isometric view 1:1

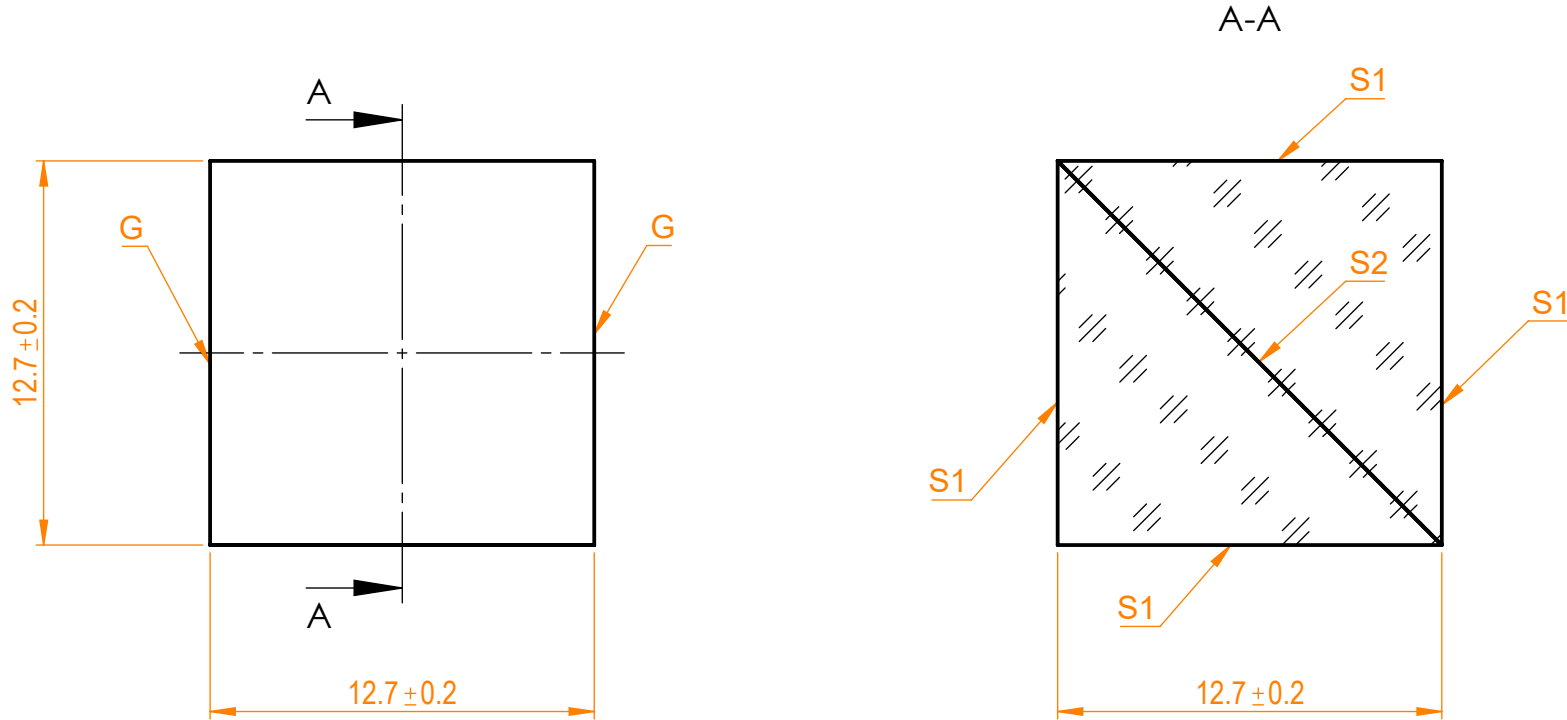

Specifications are subject to change without notice
 Dimensions are for reference only

Parameters		
	All sides	Hypotenuse
Shape	Plano	Plano
Surface flatness	$\lambda/10$ @633nm	$\lambda/10$ @633nm
Surface quality	20-10 s/d	20-10 s/d
Clear aperture	>85%	>85%
Coating	AR<0.25% @420-680nm	Rs/Tp>99.5/97% @420-680nm



HEPC beamsplitter, H=L=T=12.7 mm

Proprietary	Approved	Name	Date	Part number	Rev.	Scale
The information in this drawing is property of EKSMA Optics. Any reproduction in part or as a whole without the written permission of EKSMA Optics is prohibited.	Approved	A.K.	2021.04.22	436-1121	A	4:1
	Drawn	V.S.	2021.04.22			