

NOTES:

1. Material: UVFS;
2. G - Fine ground surface;
3. All dimensions are in mm;
4. Protective chamfers: 0.3 mm x 45°;
5. Beam deviation: <3 arcmin;
6. Typical damage threshold: >8 J/cm² @800nm;

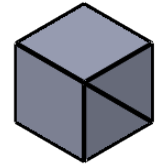

Isometric view 1:2

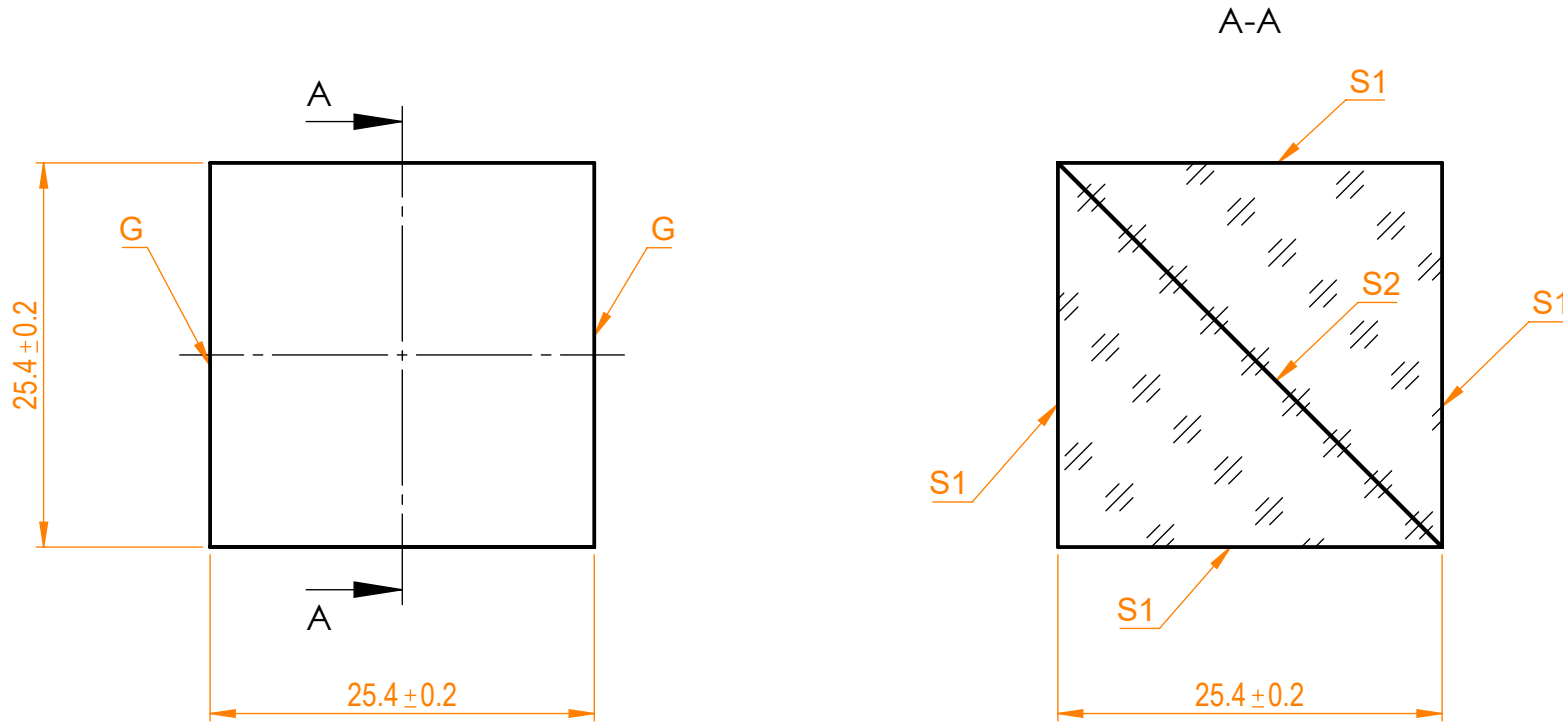

Specifications are subject to change without notice
 Dimensions are for reference only

Parameters			 info@eksmaoptics.com www.eksmaoptics.com		HEPC beamsplitter, H=L=T=25.4 mm				
	All sides	Hypotenuse			Proprietary	Name	Date	Part number	Rev.
Shape	Plano	Plano	The information in this drawing is property of EKSMA Optics. Any reproduction in part or as a whole without the written permission of EKSMA Optics is prohibited.	Approved	A.K.	2021.04.22	435-1222	A	2:1
Surface flatness	$\lambda/10$ @633nm	$\lambda/10$ @633nm		Drawn	V.S.	2021.04.22			
Surface quality	20-10 s/d	20-10 s/d							
Clear aperture	>85%	>85%							
Coating	AR<0.25% @800nm	R _s /T _p >99.5/97% @800nm							