

NOTES:

1. Material: N-BK7 (beamsplitter),  
Black anodized aluminium (housing);
2. G - Fine ground surface;
3. All dimensions are in mm;
4. Protective chamfers: 0.3 mm x 45°;
5. Beam deviation: <3 arcmin;
6. Laser damage threshold: >0.3 J/cm<sup>2</sup> at @1064nm, 10ns pulses;

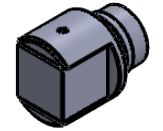

Isometric view 1:3

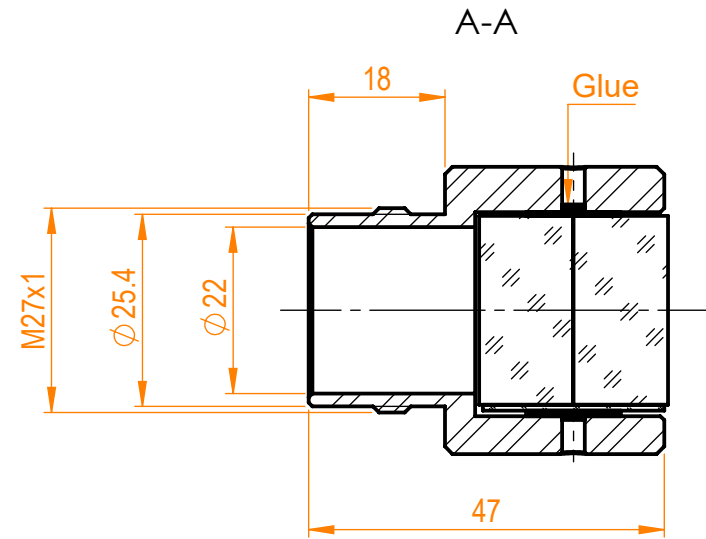
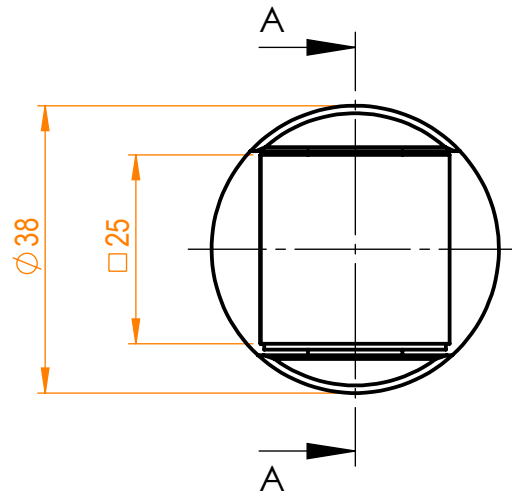

Specifications are subject to change without notice  
Dimensions are for reference only

Parameters		
	All sides	Hypotenuse
Shape	Plano	Plano
Surface flatness	$\lambda/4$ @633nm	$\lambda/4$ @633nm
Surface quality	40-20 s/d	40-20 s/d
Clear aperture	>90%	>90%
Coating	AR<0.25% @633nm	R <sub>s</sub> /T <sub>p</sub> >99.5/95% @633nm

CP beamsplitter, H=L=T=25 mm

Proprietary	Approved	Name	Date	Part number	Rev.	Scale
The information in this drawing is property of EKSMA Optics. Any reproduction in part or as a whole without the written permission of EKSMA Optics is prohibited.	Drawn	A.K.	2021.04.27	430-0254-M2P	A	1:1
	Approved	V.S.	2021.04.27			