

NOTES:

1. Material: UVFS;
2. G - Fine ground surface;
3. All dimensions are in mm;
4. Protective chamfers: 0.3 mm x 45°;
5. Parallelism: <30 arcsec;
6. Angle of incidence: 56°/ Angle of incidence tolerance: ±2°;
7. Transmitted wavefront distortion: λ/10 @633nm;
8. Extinction ratio: T<sub>p</sub>:T<sub>s</sub>> 1000:1;
9. Laser Induced Damage Threshold: >10 J/cm<sup>2</sup> @1030nm, 50Hz, 10nsec pulses;

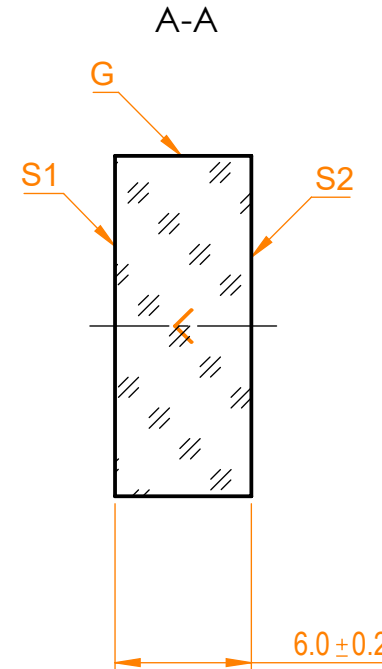

Isometric view 1:2

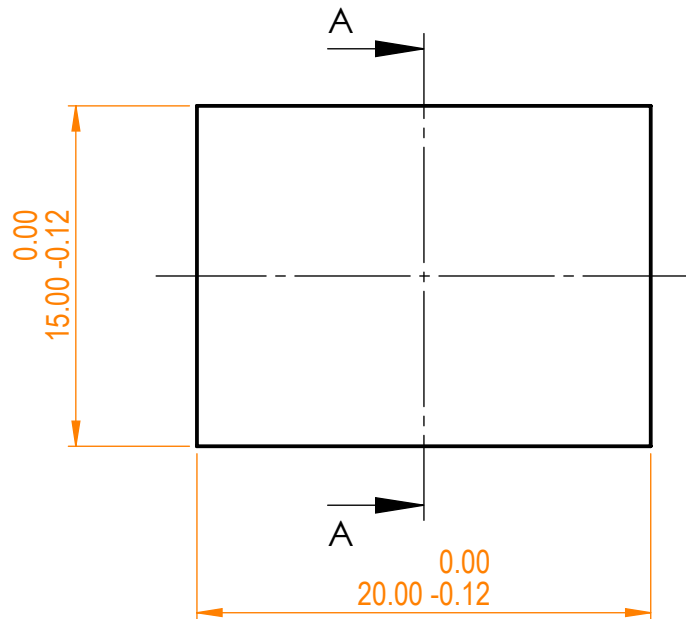

Specifications are subject to change without notice  
 Dimensions are for reference only

Parameters			 info@eksmaoptics.com www.eksmaoptics.com	TF polarizer, H=15 mm, L=20mm, T=6 mm					
	S1	S2							
Shape	Plano	Plano							
Surface quality	20-10 s/d	20-10 s/d	Proprietary	Name	Date	Part number	Rev.	Scale	
Clear aperture	>90%	>90%	The information in this drawing is property of EKSMA Optics. Any reproduction in part or as a whole without the written permission of EKSMA Optics is prohibited.	Approved	A.K.	2021.01.11	420-1478HE	A	2:1
Coating	T <sub>p</sub> >98%, T <sub>s</sub> <0.1% @1030nm	R <sub>p</sub> <0.3% @1030nm	Drawn	V.S.	2021.01.11				