

NOTES:

1. Material: N-BK7 (beamsplitter),
Black anodized aluminium (housing);
2. All dimensions are in mm;
3. Protective chamfers: 0.3 mm x 45°;
4. Beam deviation: <5 arcmin;
5. Absorption: <10%;
6. Reflection/Transmission ratio: 50/50±5% at @450-700nm;
7. Typical damage threshold: >0.1 J/cm² at @1064nm, 10Hz;

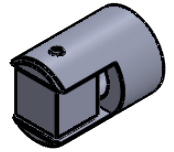

Isometric view 1:2

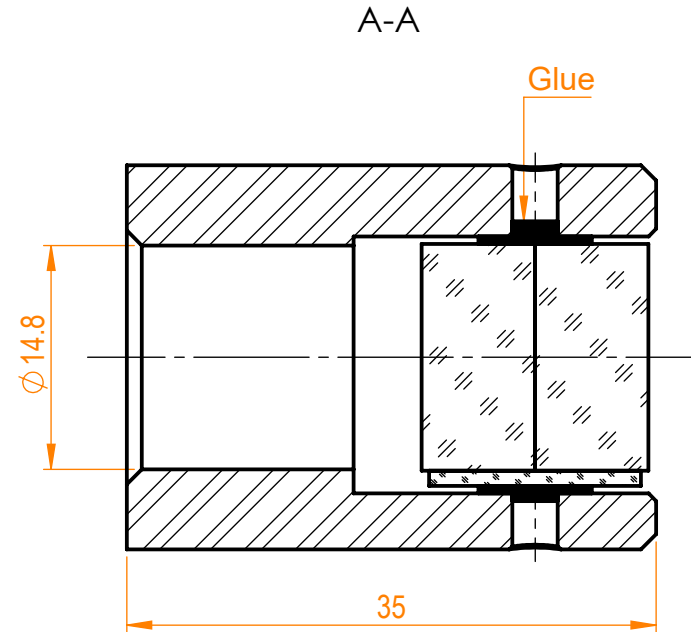
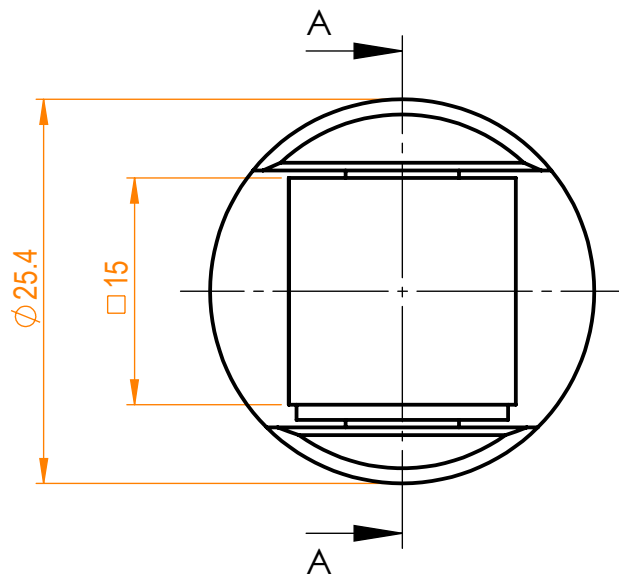

Specifications are subject to change without notice
Dimensions are for reference only

Parameters		
	All sides	Hypotenuse
Shape	Plano	Plano
Surface flatness	$\lambda/4$ @633nm	$\lambda/4$ @633nm
Surface quality	40-20 s/d	40-20 s/d
Clear aperture	>80%	>80%
Coating	AR<1% @450-700nm	$T_{p,s} = 45 \pm 5\%$ @450-700nm



NPBC beamsplitter, H=L=T=15 mm

Proprietary	Approved	Name	Date	Part number	Rev.	Scale
The information in this drawing is property of EKSMA Optics. Any reproduction in part or as a whole without the written permission of EKSMA Optics is prohibited.	Approved	A.K.	2020.12.14	351-0157-M2P	A	2:1
	Drawn	V.S.	2020.12.14			