

NOTES:

1. Material: Schott colored glass RG830;
2. G - Fine ground surface;
3. All dimensions are in mm;
4. Protective chamfers: 0.3 mm x 45°;
5. Parallelism: <3 arcmin;

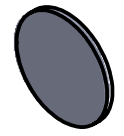

Isometric view 1:3

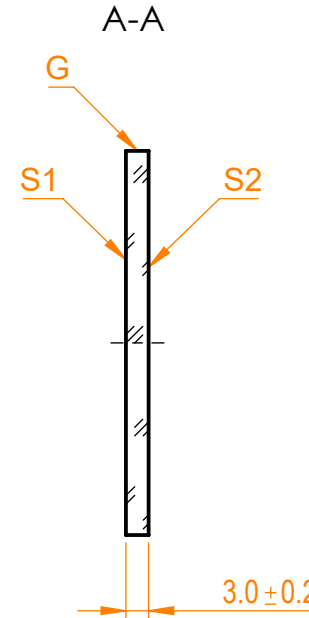
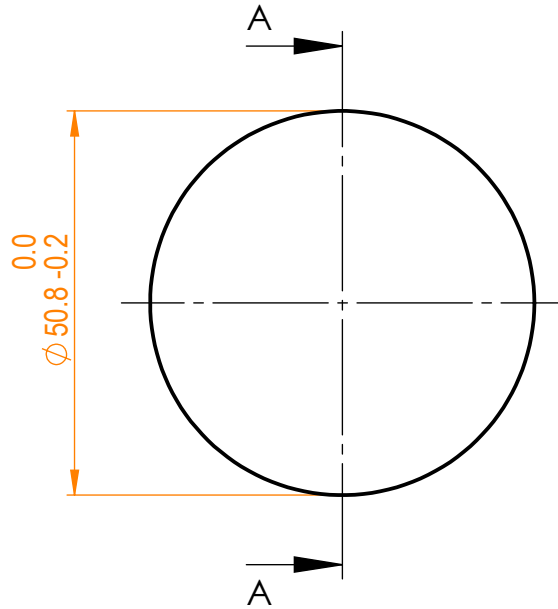

Specifications are subject to change without notice
Dimensions are for reference only

Parameters			 info@eksmaoptics.com www.eksmaoptics.com		CG filter, D=50.8 mm, T=3 mm				
	S1	S2			Proprietary	Name	Date	Part number	Rev.
Shape	Plano	Plano	The information in this drawing is property of EKSMA Optics. Any reproduction in part or as a whole without the written permission of EKSMA Optics is prohibited.	Approved	A.K.	2020.12.10	243-5830	A	1:1
Surface flatness	λ @633nm	λ @633nm			Drawn	V.S.			
Surface quality	60-40 s/d	60-40 s/d							
Clear aperture	>90%	>90%							
Coating	-	-							