

NOTES:

1. Material: Neutral Density Color Glass;
2. G - Fine ground surface;
3. Thickness depends on material;
4. All dimensions are in mm;
5. Protective chamfers: 0.3 mm x 45°;
6. Parallelism: <3 arcmin;
7. Optical density: 1.5;
8. Transmission: T>3%@546nm;

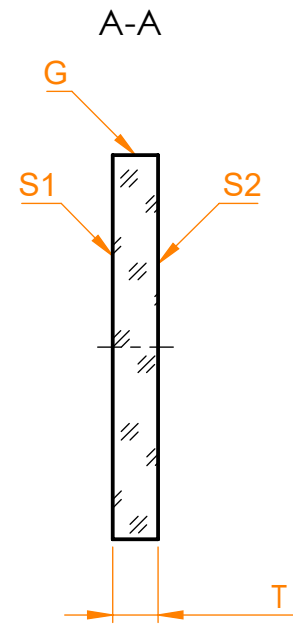

Isometric view 1:2

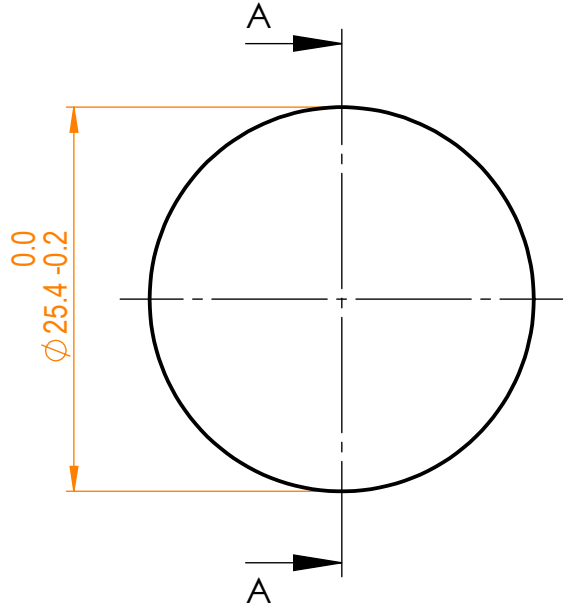

Specifications are subject to change without notice
 Dimensions are for reference only

Parameters		
	S1	S2
Shape	Plano	Plano
Surface flatness	λ @633nm	λ @633nm
Surface quality	60-40 s/d	60-40 s/d
Clear aperture	>90%	>90%
Coating	-	-



NDAT filter, D=25.4 mm, OD=1.5

Proprietary	Name	Date	Part number	Rev.	Scale
The information in this drawing is property of EKSMA Optics. Any reproduction in part or as a whole without the written permission of EKSMA Optics is prohibited.	Approved	A.K.	2020.12.10	240-2515	A
	Drawn	V.S.	2020.12.10		