

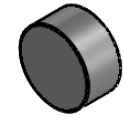

NOTES:
 1. Material: UVFS;
 2. G - Fine ground surface;
 3. All dimensions are in mm;

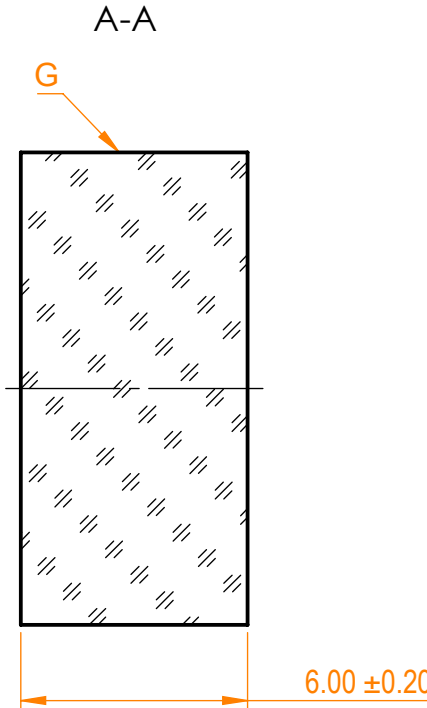

Isometric view 1:1

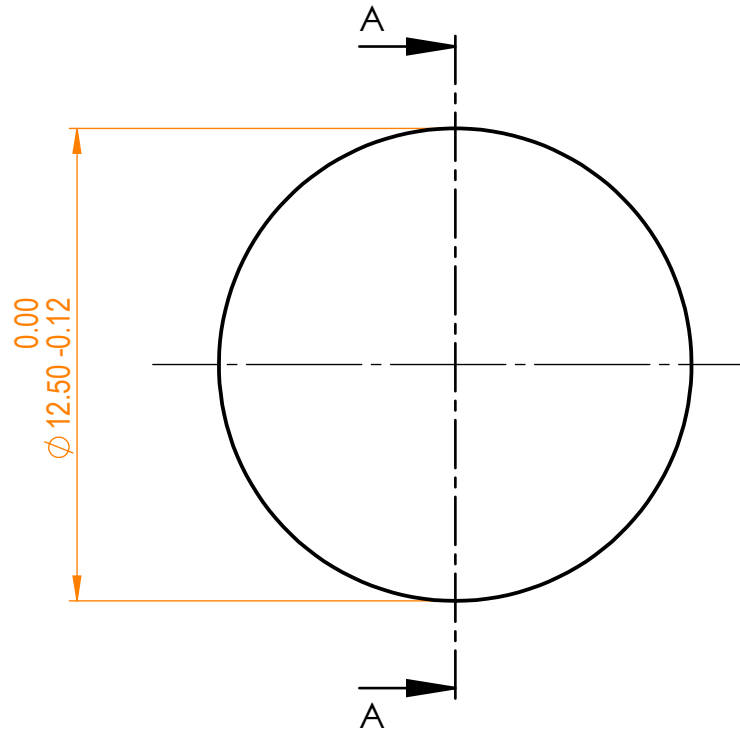

Specifications are subject to change without notice
 Dimensions are for reference only

Parameters		 info@eksmaoptics.com www.eksmaoptics.com		UVFS pl window, D=12.5 mm, T=6 mm			
Shape	Plano			Proprietary	Name	Date	Part number
Surface quality	20-10 s/d	Approved	A.K.		2019.12.05	220-1163M	A
Surface flatness	$\lambda/10$ @632.8 nm	The information in this drawing is property of EKSMA Optics. Any reproduction in part or as a whole without the written permission of EKSMA Optics is prohibited.	Drawn	A.F.	2019.12.05		
Clear aperture	$\geq 90\%$						
Protective chamfers	0.2 - 0.3 mm x 45°						
Parallelism	3 arcsec						