

NOTES:
 1. Material: BK7;
 2. G - Fine ground surface;
 3. All dimensions are in mm;

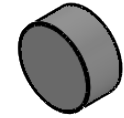

Isometric view 1:1

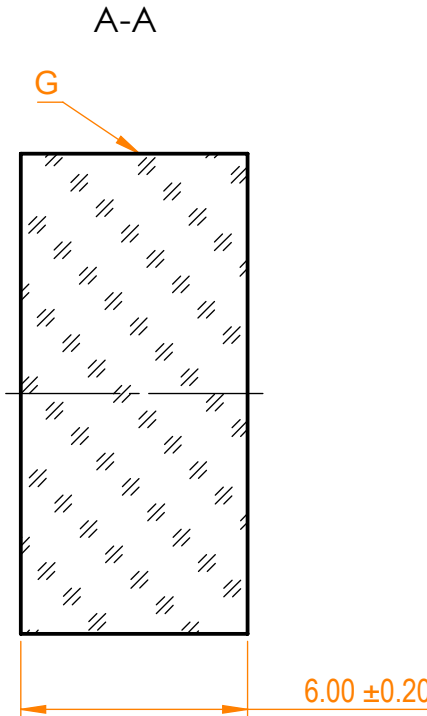
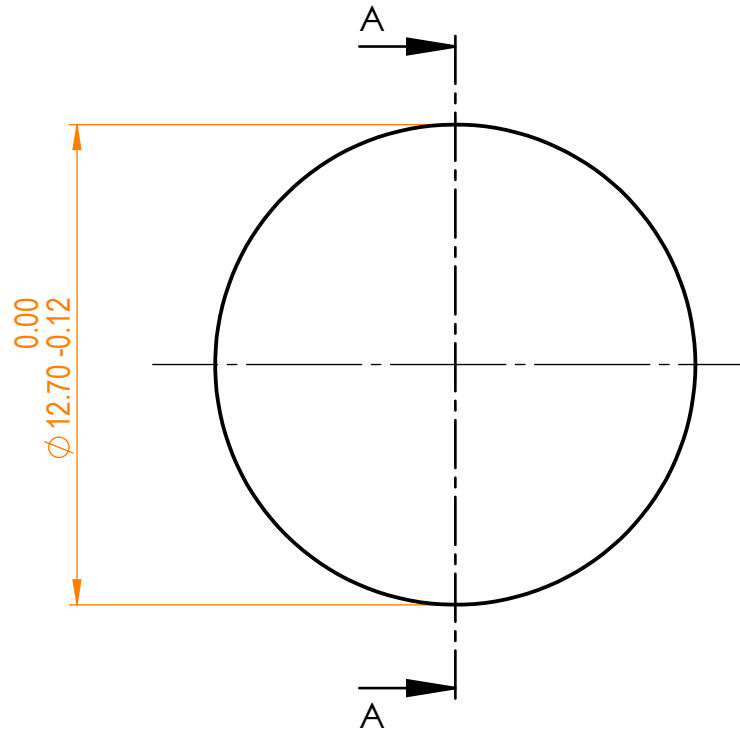

Specifications are subject to change without notice
 Dimensions are for reference only

Parameters

Shape	Plano
Surface quality	20-10 s/d
Surface flatness	$\lambda/10$ @632.8 nm
Clear aperture	$\geq 90\%$
Protective chamfers	0.2 - 0.3 mm x 45°
Parallelism	30 arcsec



BK7 pl window, D=12.7 mm, T=6 mm

Proprietary		Name	Date	Part number	Rev.	Scale
The information in this drawing is property of EKSMA Optics. Any reproduction in part or as a whole without the written permission of EKSMA Optics is prohibited.	Approved	A.K.	2019.12.05	220-0161E	A	5:1
	Drawn	A.F.	2019.12.05			