

NOTES:

1. Material: BK7;
2. Apex Angle: $170^\circ \pm 0.5^\circ$;
3. Centration error: ≤ 3 arcmin;
4. G - Fine ground surface;
5. All dimensions are in mm;

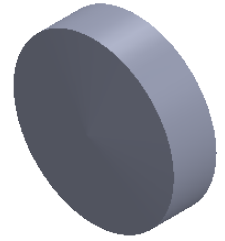

Isometric view 1:1

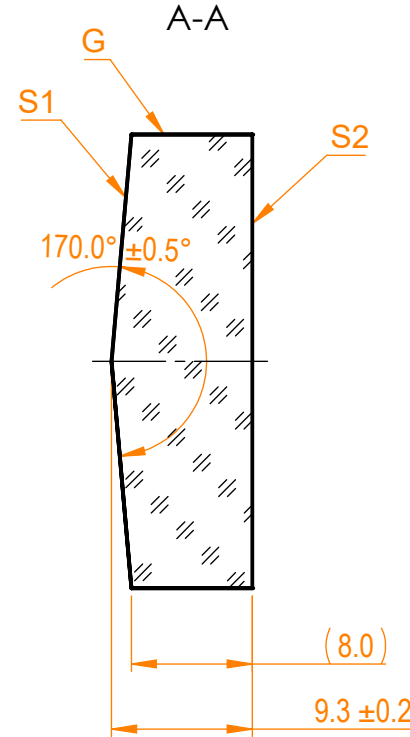
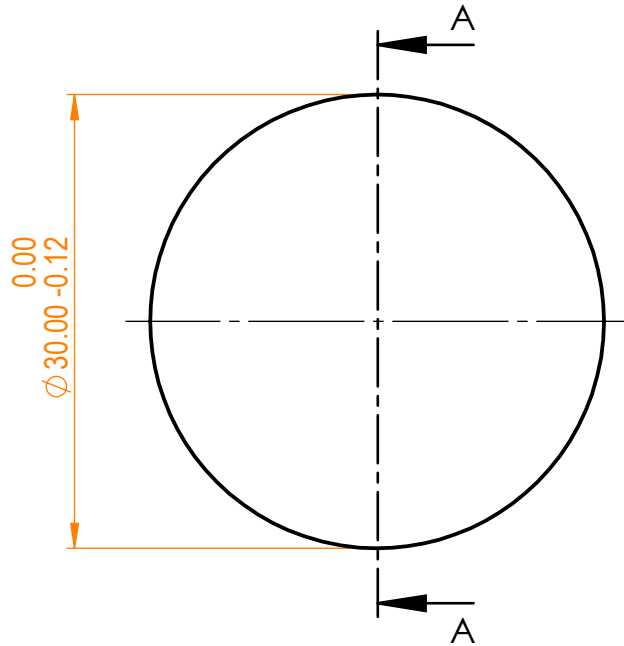

Specifications are subject to change without notice
Dimensions are for reference only

Parameters

	S1	S2
Shape	Convex	Plano
Apex rounding	dia <3 mm	-
Surface quality	60-40 s/d	60-40 s/d
Surface irregularity	1λ @632.8 nm	1λ @632.8 nm
Clear aperture	≥90%	≥90%
Protective chamfers	0.2 - 0.3 mm x 45°	0.2 - 0.3 mm x 45°



BK7 pl/cx axicon lens,
D=30.0 mm, 170° apex angle

Proprietary	Approved	Name	Date	Part number	Rev.	Scale
The information in this drawing is property of EKSMA Optics. Any reproduction in part or as a whole without the written permission of EKSMA Optics is prohibited.	Approved	A.K.	2020.03.20	130-0370	A	2:1
	Drawn	M.B.	2020.03.20			