

NOTES:

1. Material: UVFS;
2. Design wavelength: 780 nm;
3. Focal length: F=+60 mm ± 0.05%;
4. Centration error: ≤ 3 arcmin;
5. G - Fine ground surface;
6. All dimensions are in mm;
7. Clear aperture: ≥90%;

	R	k	A ₄	A ₆
S1	27.22	-0.65	4.62299E-07	1.04788E-10
S2	Infinity	-	-	-

$$z = \frac{y^2}{R(1 + \sqrt{1 - (1+k)y^2/R^2})} + A_4y^4 + A_6y^6$$



Isometric view 1:1

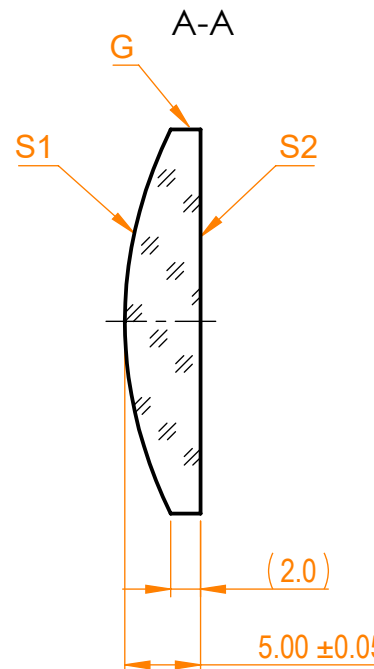
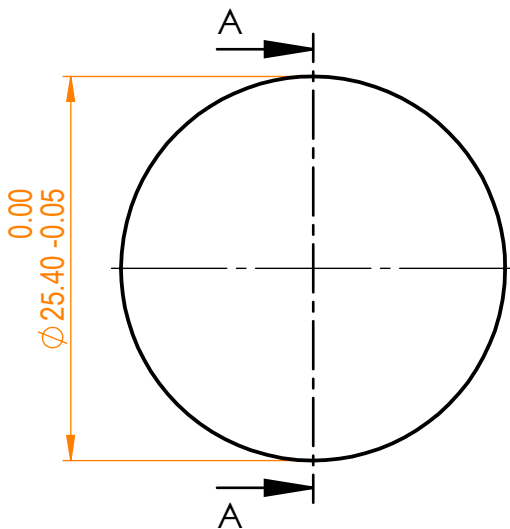

Specifications are subject to change without notice
Dimensions are for reference only

Parameters

	S1	S2
Shape	Convex	Plano
Surface quality	40-20 s/d	40-20 s/d
Surface irregularity	-	λ/4 @632.8 nm
Asphere figure error P-V	±1 μm	-
Surface form deviation RMS	≤0.5 μm	-
Protective chamfers	0.2 - 0.3 mm x 45°	0.2 - 0.3 mm x 45°



UVFS pl/cx aspheric lens,
D=25.4 mm, F=60 mm

Proprietary	Approved	Name	Date	Part number	Rev.	Scale
The information in this drawing is property of EKSMA Optics. Any reproduction in part or as a whole without the written permission of EKSMA Optics is prohibited.	Drawn	A.K.	2020.03.18	117-2560	A	2:1
		M.B.	2020.03.18			