

NOTES:

1. Material: CaF₂;
2. Design wavelength: 2940 nm;
3. Focal length: F=-75 mm ± 2%;
4. Centration error: ≤ 3 arcmin;
5. G - Fine ground surface;
6. All dimensions are in mm;

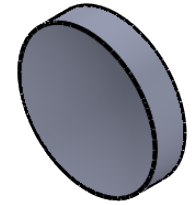

Isometric view 1:1

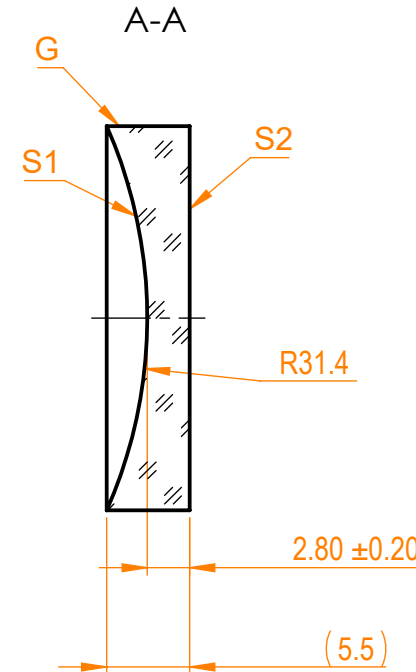
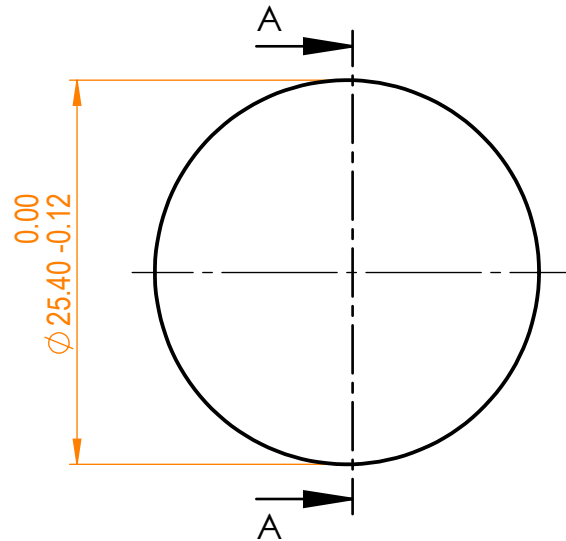

Specifications are subject to change without notice
Dimensions are for reference only

Parameters

	S1	S2
Shape	Concave	Plano
Radius of curvature	31.4	Infinity
Surface quality	40-20 s/d	40-20 s/d
Surface irregularity	λ/8 @632.8 nm	λ/8 @632.8 nm
Clear aperture	≥90%	≥90%
Protective chamfers	0.2 - 0.3 mm x 45°	0.2 - 0.3 mm x 45°



CaF₂ pl/cv lens, D=25.4 mm, F=-75 mm

Proprietary	Name	Date	Part number	Rev.	Scale
The information in this drawing is property of EKSMA Optics. Any reproduction in part or as a whole without the written permission of EKSMA Optics is prohibited.	Approved	A.K.	2019.07.25	112-5209E	A
	Drawn	M.B.	2019.07.25		