

NOTES:

- 1. Material: CaF₂;
- 2. Design wavelength: 2940 nm;
- 3. Focal length: F=-250 mm ± 2%;
- 4. Centration error: ≤ 3 arcmin;
- 5. G - Fine ground surface;
- 6. All dimensions are in mm;

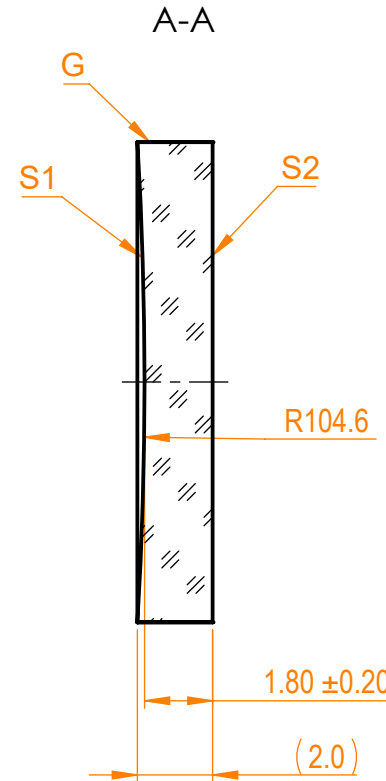

Isometric view 1:1

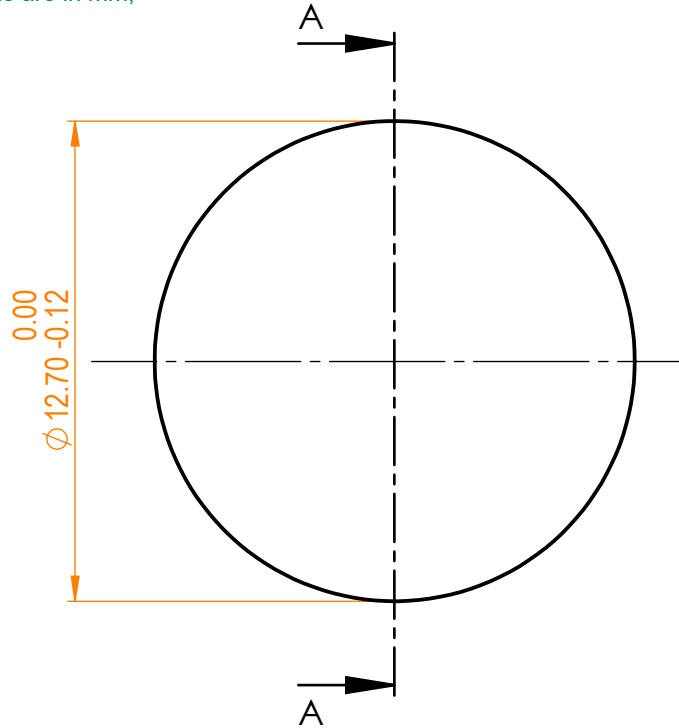

Specifications are subject to change without notice
Dimensions are for reference only

Parameters

	S1	S2
Shape	Concave	Plano
Radius of curvature	104.6	Infinity
Surface quality	40-20 s/d	40-20 s/d
Surface irregularity	λ/8 @632.8 nm	λ/8 @632.8 nm
Clear aperture	≥90%	≥90%
Protective chamfers	0.2 - 0.3 mm x 45°	0.2 - 0.3 mm x 45°



CaF₂ pl/cv lens, D=12.7 mm, F=-250 mm

Proprietary	Approved	Name	Date	Part number	Rev.	Scale
The information in this drawing is property of EKSMA Optics. Any reproduction in part or as a whole without the written permission of EKSMA Optics is prohibited.	Approved	A.K.	2019.07.25	112-5130E	A	5:1
	Drawn	M.B.	2019.07.25			