

NOTES:

- 1. Material: UVFS;
- 2. Design wavelength: 355 nm;
- 3. Focal length: $F = -250 \text{ mm} \pm 2\%$;
- 4. Centration error: $\leq 3 \text{ arcmin}$;
- 5. G - Fine ground surface;
- 6. All dimensions are in mm;

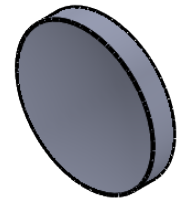

Isometric view 1:2

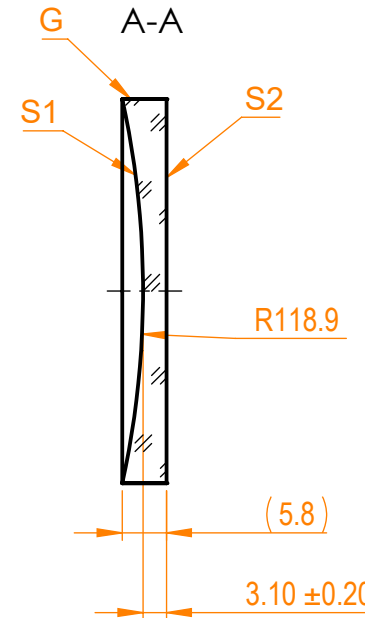
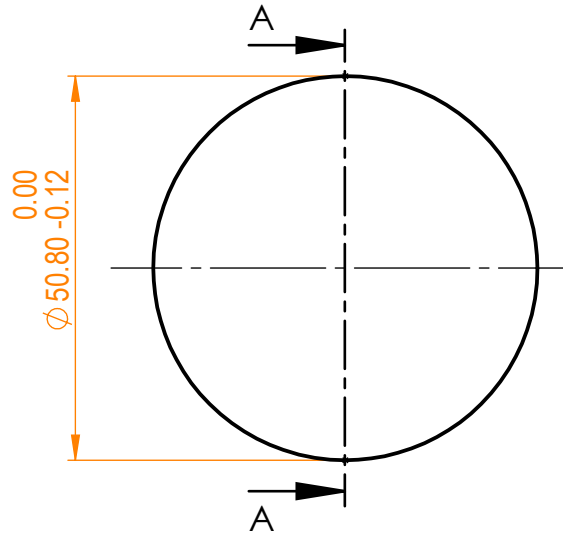

Specifications are subject to change without notice
Dimensions are for reference only

Parameters			 info@eksmaoptics.com www.eksmaoptics.com		UVFS pl/cv lens, D=50.8 mm, F=-250 mm				
	S1	S2			Name	Date	Part number	Rev.	Scale
Shape	Concave	Plano	Proprietary	Approved	A.K.	2019.09.30	112-1517E	A	1:1
Radius of curvature	118.9	Infinity							
Surface quality	40-20 s/d	40-20 s/d							
Surface irregularity	$\lambda/8 @632.8 \text{ nm}$	$\lambda/8 @632.8 \text{ nm}$							
Clear aperture	$\geq 90\%$	$\geq 90\%$							
Protective chamfers	0.2 - 0.3 mm x 45°	0.2 - 0.3 mm x 45°							