

NOTES:

- 1. Material: UVFS;
- 2. Design wavelength: 355 nm;
- 3. Focal length: $F = -75 \text{ mm} \pm 2\%$;
- 4. Centration error: $\leq 3 \text{ arcmin}$;
- 5. G - Fine ground surface;
- 6. All dimensions are in mm;

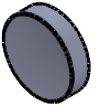

Isometric view 1:1

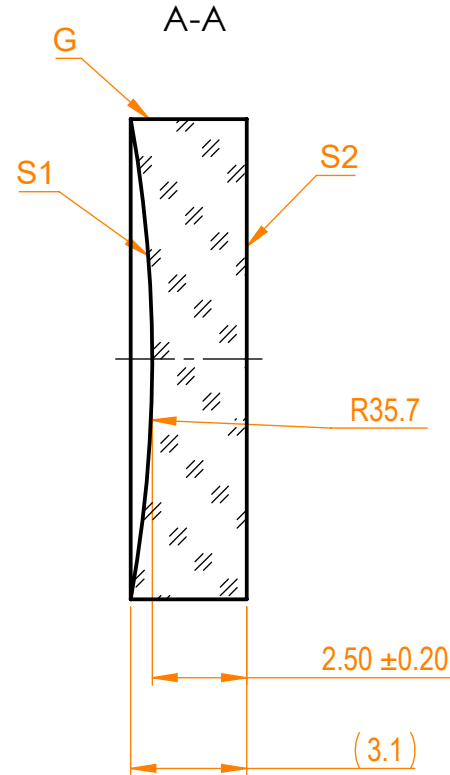
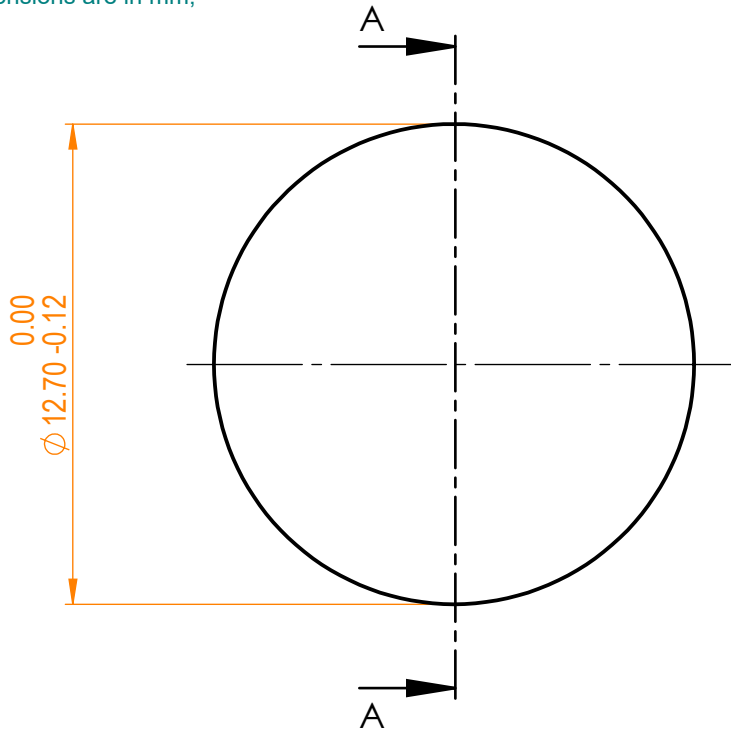

Specifications are subject to change without notice
Dimensions are for reference only

Parameters

	S1	S2
Shape	Concave	Plano
Radius of curvature	35.7	Infinity
Surface quality	40-20 s/d	40-20 s/d
Surface irregularity	$\lambda/8 @ 632.8 \text{ nm}$	$\lambda/8 @ 632.8 \text{ nm}$
Clear aperture	$\geq 90\%$	$\geq 90\%$
Protective chamfers	0.2 - 0.3 mm x 45°	0.2 - 0.3 mm x 45°



UVFS pl/cv lens, D=12.7 mm, F=-75 mm

Proprietary	Approved	Name	Date	Part number	Rev.	Scale
The information in this drawing is property of EKSMA Optics. Any reproduction in part or as a whole without the written permission of EKSMA Optics is prohibited.	Approved	A.K.	2019.07.20	112-1111E	A	5:1
	Drawn	M.B.	2019.07.20			