

**NOTES:**

1. Material: N-BK7;
2. Design wavelength: 546 nm;
3. Focal length:  $F = -100 \text{ mm} \pm 2\%$ ;
4. Centration error:  $\leq 3 \text{ arcmin}$ ;
5. G - Fine ground surface;
6. All dimensions are in mm;

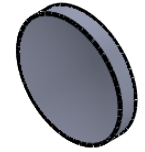

Isometric view 1:2

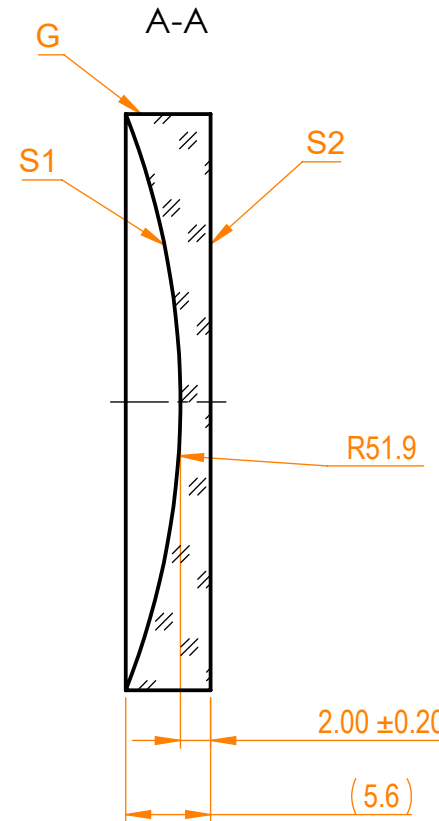
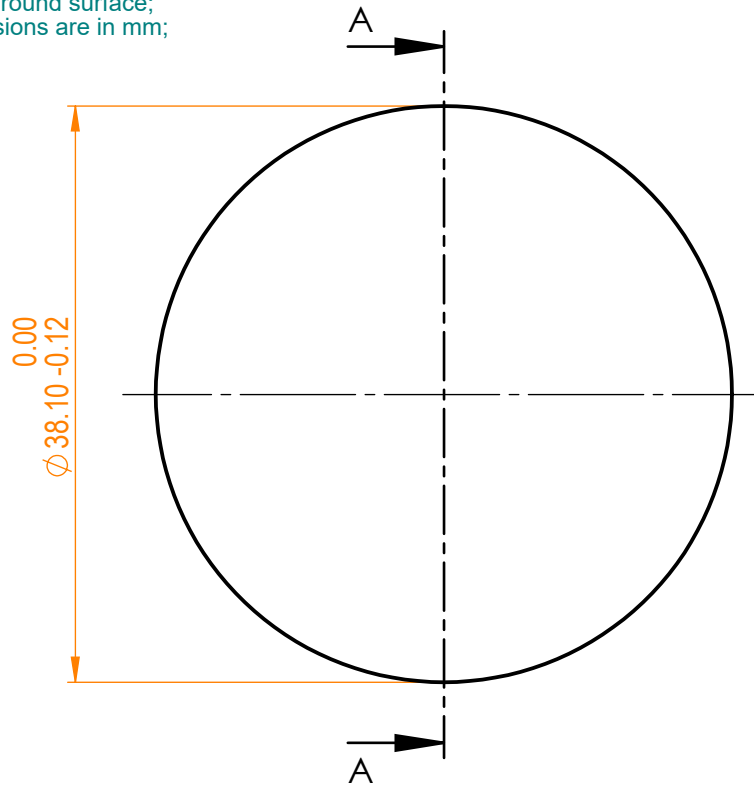

Specifications are subject to change without notice  
Dimensions are for reference only

Parameters

	S1	S2
Shape	Concave	Plano
Radius of curvature	51.9	Infinity
Surface quality	40-20 s/d	40-20 s/d
Surface irregularity	$\lambda/8 @ 632.8 \text{ nm}$	$\lambda/8 @ 632.8 \text{ nm}$
Clear aperture	$\geq 90\%$	$\geq 90\%$
Protective chamfers	0.2 - 0.3 mm x 45°	0.2 - 0.3 mm x 45°



N-BK7 pl/cv lens, D=38.1 mm, F=-100 mm

Proprietary	Name	Date	Part number	Rev.	Scale
The information in this drawing is property of EKSMA Optics. Any reproduction in part or as a whole without the written permission of EKSMA Optics is prohibited.	Approved	A.K.	2019.06.20	112-0409E	A
	Drawn	M.B.	2019.06.20		