

- NOTES:
 1. Material: N-BK7;
 2. Design wavelength: 546 nm;
 3. Focal length: $F=+200\text{ mm} \pm 2\%$;
 4. Centration error: $\leq 3\text{ arcmin}$;
 5. G - Fine ground surface;
 6. All dimensions are in mm;

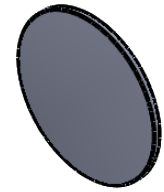

Isometric view 1:2

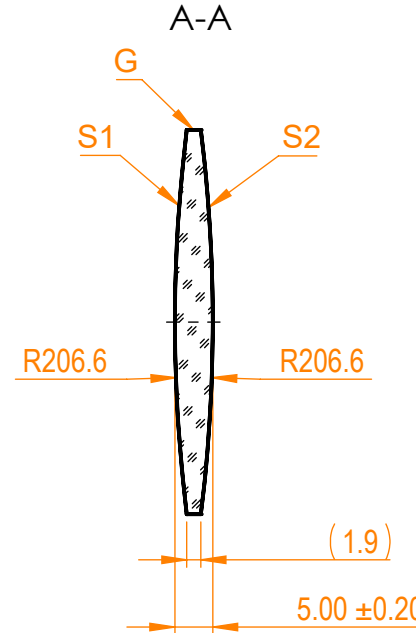
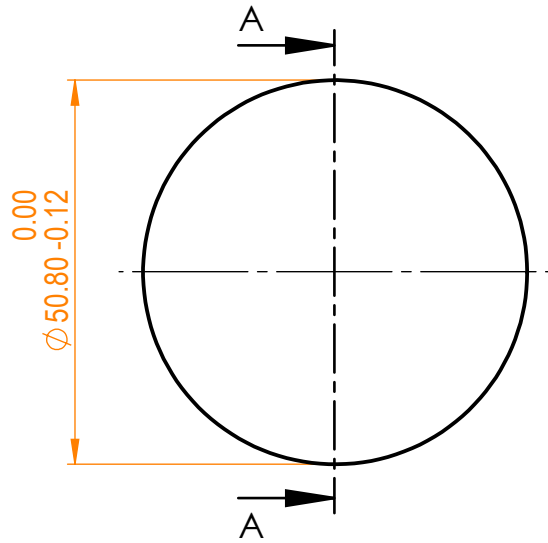

Specifications are subject to change without notice
 Dimensions are for reference only

Parameters

	S1	S2
Shape	Convex	Convex
Radius of curvature	206.6	206.6
Surface quality	40-20 s/d	40-20 s/d
Surface irregularity	$\lambda/8$ @632.8 nm	$\lambda/8$ @632.8 nm
Clear aperture	$\geq 90\%$	$\geq 90\%$
Protective chamfers	0.2 - 0.3 mm x 45°	0.2 - 0.3 mm x 45°



N-BK7 bi/cx lens, D=50.8 mm, F=200 mm

Proprietary	Approved	Name	Date	Part number	Rev.	Scale
The information in this drawing is property of EKSMA Optics. Any reproduction in part or as a whole without the written permission of EKSMA Optics is prohibited.	Approved	A.K.	2019.05.22	111-0514E	A	1:1
	Drawn	M.B.	2019.05.22			