

NOTES:

1. Material: UVFS;
2. Design wavelength: 355 nm;
3. Focal length: $F=+2500 \text{ mm} \pm 2\%$;
4. Centration error: $\leq 3 \text{ arcmin}$;
5. G - Fine ground surface;
6. All dimensions are in mm;

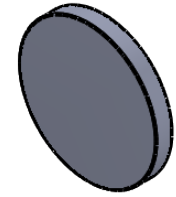

Isometric view 1:2

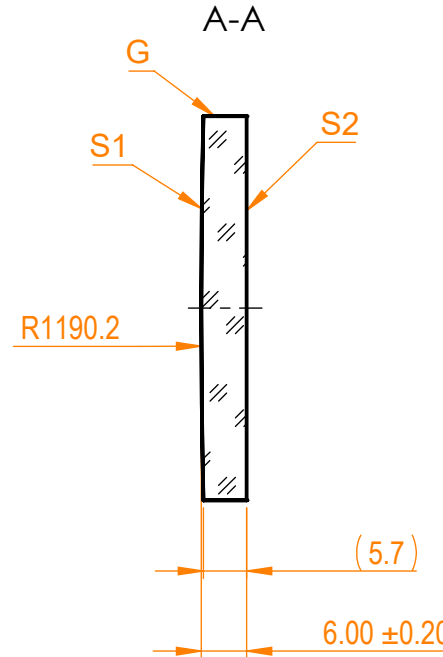
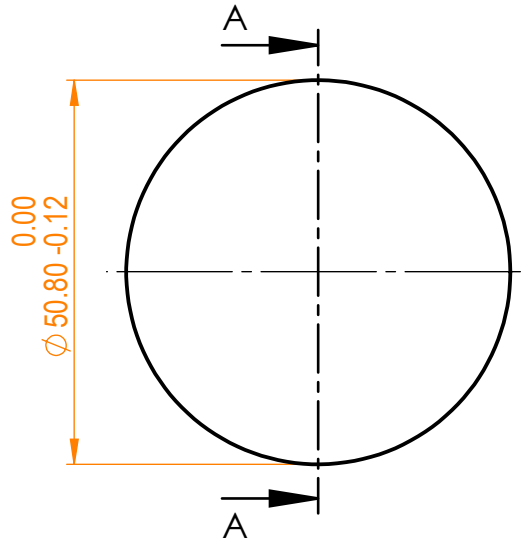

Specifications are subject to change without notice
Dimensions are for reference only

Parameters

| | S1 | S2 |
|----------------------|-------------------------------|-------------------------------|
| Shape | Convex | Plano |
| Radius of curvature | 1190.2 | Infinity |
| Surface quality | 40-20 s/d | 40-20 s/d |
| Surface irregularity | $\lambda/8 @632.8 \text{ nm}$ | $\lambda/8 @632.8 \text{ nm}$ |
| Clear aperture | $\geq 90\%$ | $\geq 90\%$ |
| Protective chamfers | 0.2 - 0.3 mm x 45° | 0.2 - 0.3 mm x 45° |



UVFS pl/cx lens, D=50.8 mm, F=2500 mm

| Proprietary | Approved | Name | Date | Part number | Rev. | Scale |
|---|----------|------|------------|-------------|------|-------|
| The information in this drawing is property of EKSMA Optics. Any reproduction in part or as a whole without the written permission of EKSMA Optics is prohibited. | Approved | A.K. | 2019.04.15 | 110-1564E | A | 1:1 |
| | Drawn | M.B. | 2019.04.15 | | | |