

**NOTES:**

1. Material: UVFS;
2. Design wavelength: 355 nm;
3. Focal length: F=+200 mm ± 2%;
4. Centration error: ≤ 3 arcmin;
5. G - Fine ground surface;
6. All dimensions are in mm;

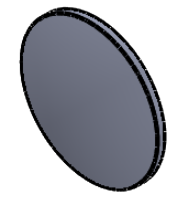

Isometric view 1:2

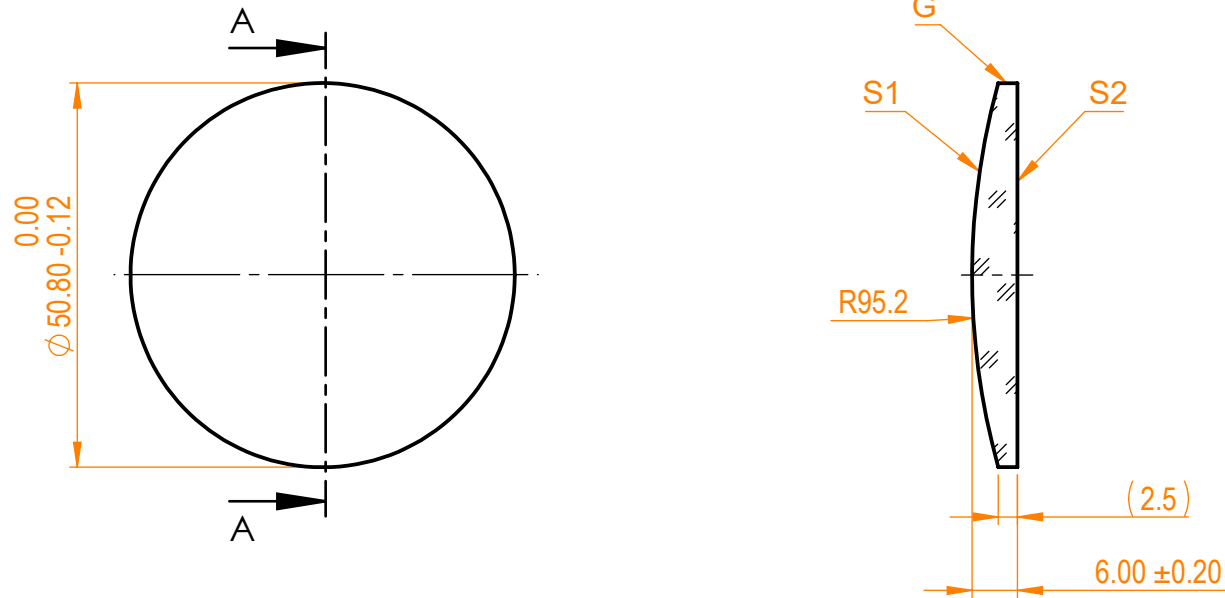

Specifications are subject to change without notice  
 Dimensions are for reference only

Parameters			 info@eksmaoptics.com www.eksmaoptics.com		UVFS pl/cx lens, D=50.8 mm, F=200 mm				
	S1	S2			Proprietary	Name	Date	Part number	Rev.
Shape	Convex	Plano	The information in this drawing is property of EKSMA Optics. Any reproduction in part or as a whole without the written permission of EKSMA Optics is prohibited.	Approved	A.K.	2019.03.28	110-1515E	A	1:1
Radius of curvature	95.2	Infinity							
Surface quality	40-20 s/d	40-20 s/d							
Surface irregularity	λ/8 @632.8 nm	λ/8 @632.8 nm							
Clear aperture	≥90%	≥90%							
Protective chamfers	0.2 - 0.3 mm x 45°	0.2 - 0.3 mm x 45°							