

- NOTES:
 1. Material: N-BK7;
 2. Design wavelength: 546 nm;
 3. Focal length: $F=+350 \text{ mm} \pm 2\%$;
 4. Centration error: $\leq 3 \text{ arcmin}$;
 5. G - Fine ground surface;
 6. All dimensions are in mm;

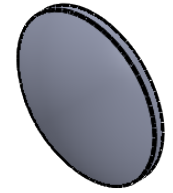
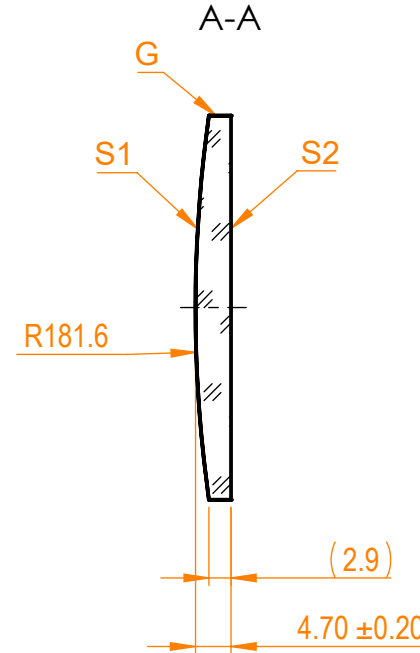
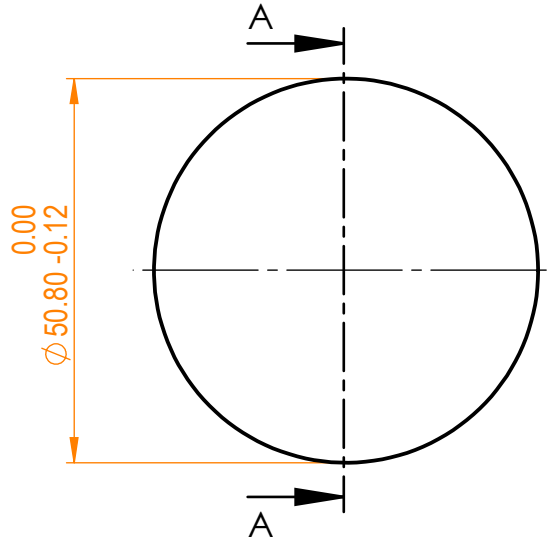

Isometric view 1:2

Specifications are subject to change without notice
 Dimensions are for reference only

Parameters

	S1	S2
Shape	Convex	Plano
Radius of curvature	181.6	Infinity
Surface quality	40-20 s/d	40-20 s/d
Surface irregularity	$\lambda/8 @632.8 \text{ nm}$	$\lambda/8 @632.8 \text{ nm}$
Clear aperture	$\geq 90\%$	$\geq 90\%$
Protective chamfers	0.2 - 0.3 mm x 45°	0.2 - 0.3 mm x 45°



N-BK7 pl/cx lens, D=50.8 mm, F=350 mm

Proprietary	Name	Date	Part number	Rev.	Scale
The information in this drawing is property of EKSMA Optics. Any reproduction in part or as a whole without the written permission of EKSMA Optics is prohibited.	Approved	A.K.	2019.03.01	110-0519E	A
	Drawn	M.B.	2019.03.01		