

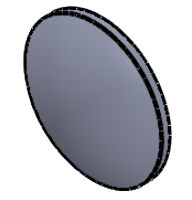

- NOTES:
 1. Material: N-BK7;
 2. Design wavelength: 546 nm;
 3. Focal length: $F=+300\text{ mm} \pm 2\%$;
 4. Centration error: $\leq 3\text{ arcmin}$;
 5. G - Fine ground surface;
 6. All dimensions are in mm;

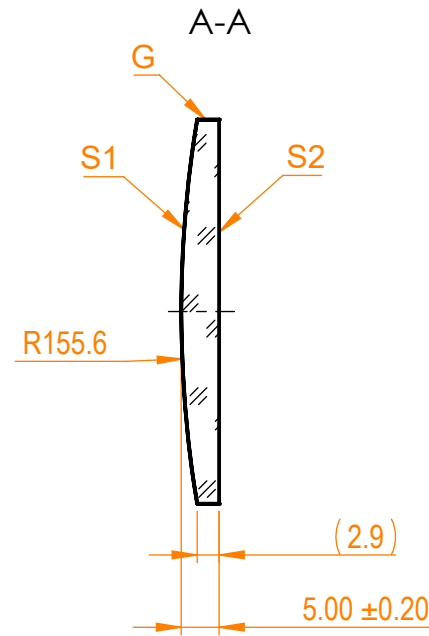
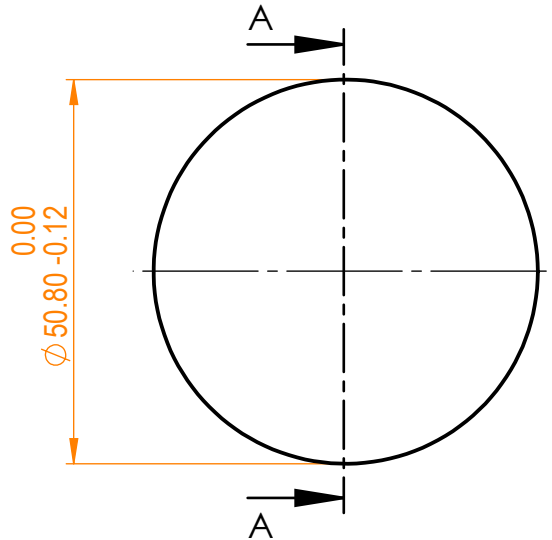

Isometric view 1:2

Specifications are subject to change without notice
 Dimensions are for reference only

Parameters			 info@eksmaoptics.com www.eksmaoptics.com		N-BK7 pl/cx lens, D=50.8 mm, F=300 mm				
	S1	S2			Name	Date	Part number	Rev.	Scale
Shape	Convex	Plano	Proprietary	Approved	A.K.	2019.03.01	110-0515E	A	1:1
Radius of curvature	155.6	Infinity							
Surface quality	40-20 s/d	40-20 s/d	The information in this drawing is property of EKSMA Optics. Any reproduction in part or as a whole without the written permission of EKSMA Optics is prohibited.						
Surface irregularity	$\lambda/8 @632.8\text{ nm}$	$\lambda/8 @632.8\text{ nm}$							
Clear aperture	$\geq 90\%$	$\geq 90\%$							
Protective chamfers	0.2 - 0.3 mm x 45°	0.2 - 0.3 mm x 45°							