

NOTES:

- 1. Material: N-BK7;
- 2. Design wavelength: 546 nm;
- 3. Focal length: F=+250 mm ± 2%;
- 4. Centration error: ≤ 3 arcmin;
- 5. G - Fine ground surface;
- 6. All dimensions are in mm;

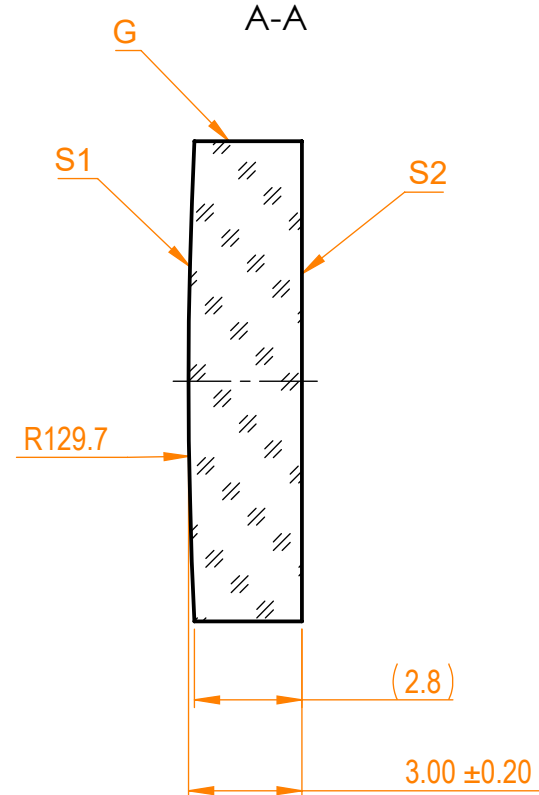

Isometric view 1:1

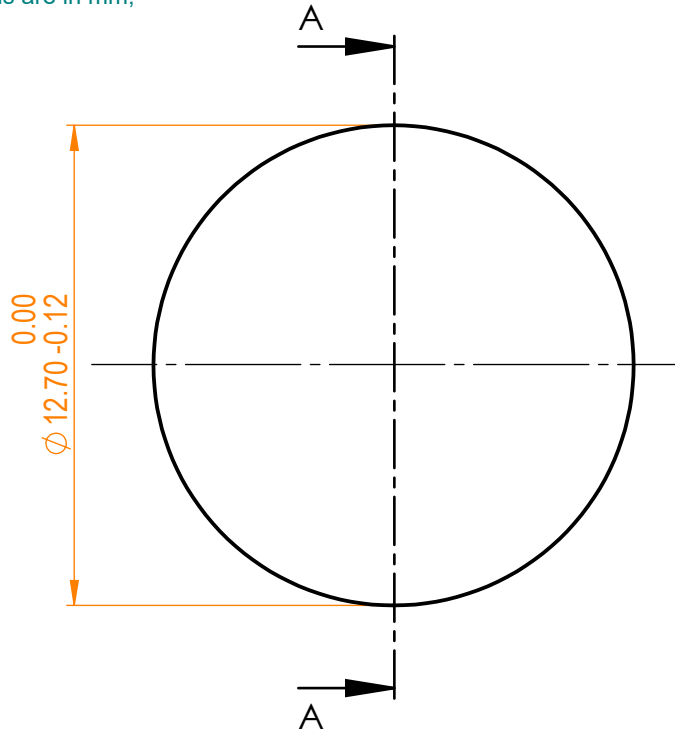

Specifications are subject to change without notice
 Dimensions are for reference only

Parameters

	S1	S2
Shape	Convex	Plano
Radius of curvature	129.7	Infinity
Surface quality	40-20 s/d	40-20 s/d
Surface irregularity	λ/8 @632.8 nm	λ/8 @632.8 nm
Clear aperture	≥90%	≥90%
Protective chamfers	0.2 - 0.3 mm x 45°	0.2 - 0.3 mm x 45°



N-BK7 pl/cx lens, D=12.7 mm, F=250 mm

Proprietary	Name	Date	Part number	Rev.	Scale
The information in this drawing is property of EKSMA Optics. Any reproduction in part or as a whole without the written permission of EKSMA Optics is prohibited.	Approved	A.K.	2019.02.01	110-0125E	A
	Drawn	M.B.	2019.02.01		