

NOTES:

1. Material: N-BK7;
2. G - Fine ground surface;
3. All dimensions are in mm;
4. Wedge: <3 min;
5. Protective chamfers: 0.3 mm x 45°;
6. Laser Induced Damage Threshold:
 - > 0.25 J/cm² at @800nm, 50Hz, 94fsec pulses,
 - > 1.8 J/cm² at @1064nm, 50Hz, 11nsec pulses;

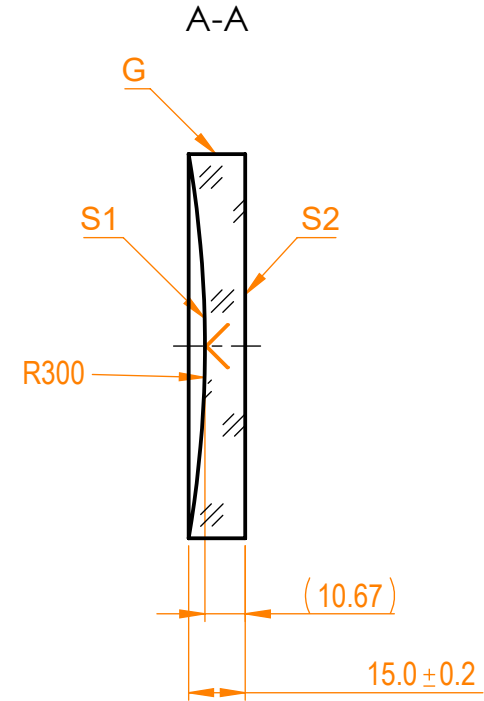

Isometric view 1:8

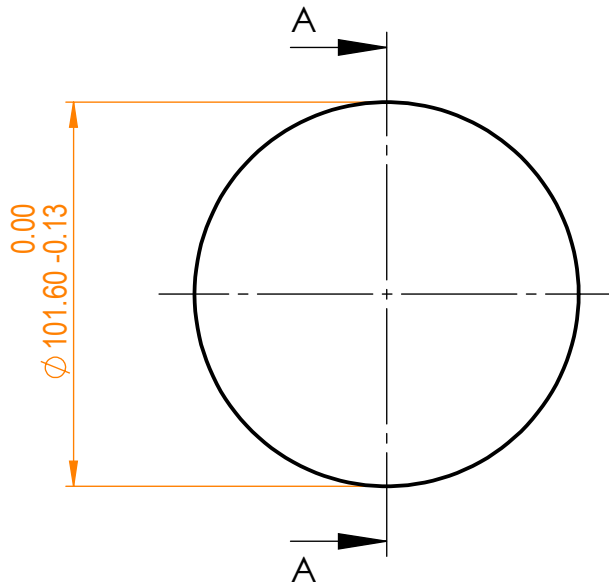

Specifications are subject to change without notice
 Dimensions are for reference only

		Parameters		 info@eksmaoptics.com www.eksmaoptics.com		N-BK7 pl/cv mirror, D=101.6 mm, T=15 mm				
		S1	S2			Name	Date	Part number	Rev.	Scale
Shape		Concave	Plano	Proprietary	Approved	A.K.	2020.11.16	098-0125R-300	A	1:2
Radius of curvature		300	Infinity							
Surface flatness		λ/10 @633nm	λ @633nm per inch							
Surface quality		40-20 s/d	80-50 s/d							
Clear aperture		>90%	>90%							
Coating		Protected silver Ravg>96%@400nm - IR	Uncoated							