

**NOTES:**

1. Material: N-BK7;
2. G - Fine ground surface;
3. All dimensions are in mm;
4. Wedge: <3 min;
5. Protective chamfers: 0.3 mm x 45°;
6. Laser Induced Damage Threshold:
  - > 0.25 J/cm<sup>2</sup> at @800nm, 50Hz, 94fsec pulses,
  - > 1.8 J/cm<sup>2</sup> at @1064nm, 50Hz, 11nsec pulses;

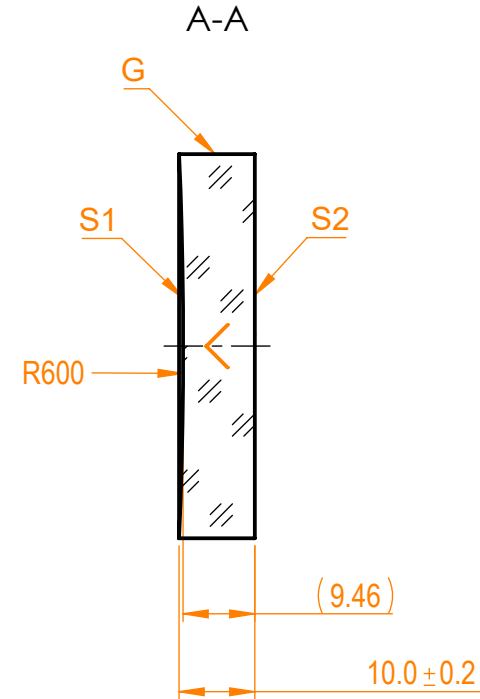

Isometric view 1:4

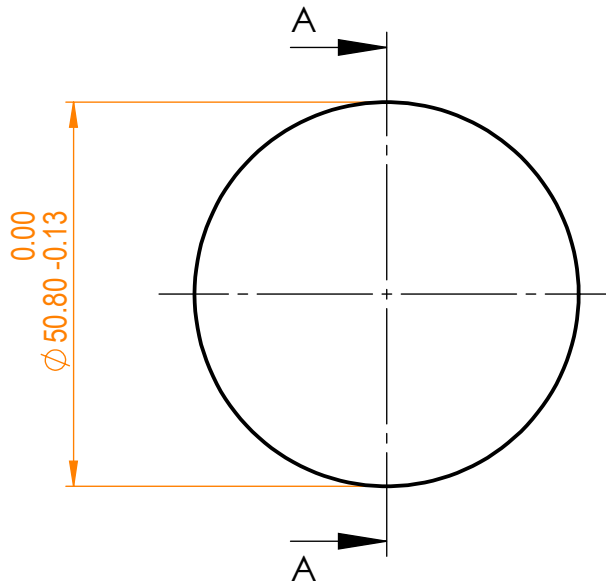

Specifications are subject to change without notice  
 Dimensions are for reference only

Parameters		 info@eksmaoptics.com www.eksmaoptics.com		N-BK7 pl/cv mirror, D=50.8 mm, T=10 mm					
	S1			S2	Name	Date	Part number	Rev.	Scale
Shape	Concave	Plano	Proprietary	Approved	A.K.	2020.11.16	095-0125R-600	A	1:1
Radius of curvature	600	Infinity							
Surface flatness	λ/10 @633nm	λ @633nm per inch							
Surface quality	40-20 s/d	80-50 s/d							
Clear aperture	>90%	>90%							
Coating	Protected silver Ravg>96%@400nm - IR	Uncoated							