

NOTES:

1. Material: UVFS;
2. G - Fine ground surface;
3. All dimensions are in mm;
4. Wedge: <3 min;
5. Protective chamfers: 0.3 mm x 45°;
6. Laser Induced Damage Threshold:
 - > 0.1 J/cm² at @355nm, 50Hz, 5.7nsec pulses,
 - > 0.25 J/cm² at @1064nm, 50Hz, 11nsec pulses;

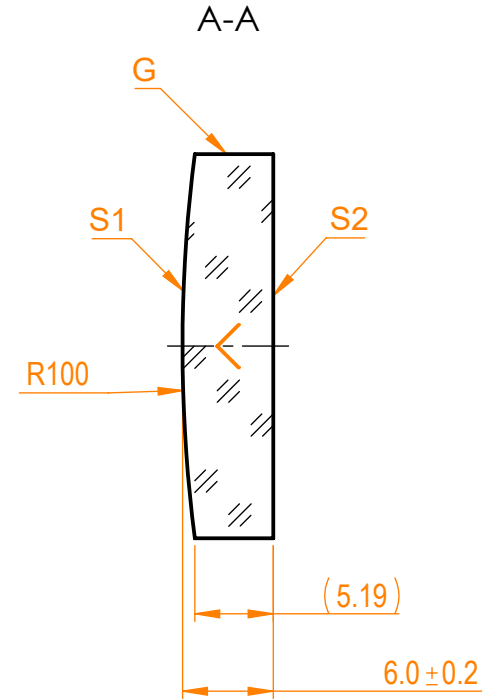

Isometric view 1:2



Specifications are subject to change without notice
Dimensions are for reference only

Parameters						UVFS pl/cx mirror, D=25.4 mm, T=6 mm				
	S1	S2								
Shape	Convex	Plano								
Radius of curvature	100	Infinity								
Surface flatness	$\lambda/10$ @633nm	λ @633nm								
Surface quality	40-20 s/d	80-50 s/d								
Clear aperture	>90%	>90%								
Coating	Protected aluminium Ravg>86%@300nm - IR	Uncoated								
				Proprietary		Name	Date	Part number	Rev.	Scale
				The information in this drawing is property of EKSMA Optics. Any reproduction in part or as a whole without the written permission of EKSMA Optics is prohibited.	Approved	A.K.	2020.11.16	092-3215R+100	A	2:1
					Drawn	V.S.	2020.11.16			