

**NOTES:**

1. Material: UVFS;
2. G - Fine ground surface;
3. All dimensions are in mm;
4. Wedge: <3 min;
5. Protective chamfers: 0.3 mm x 45°;
6. Laser Induced Damage Threshold: > 1 J/cm<sup>2</sup> at @1064nm, 50Hz, 11nsec pulses;

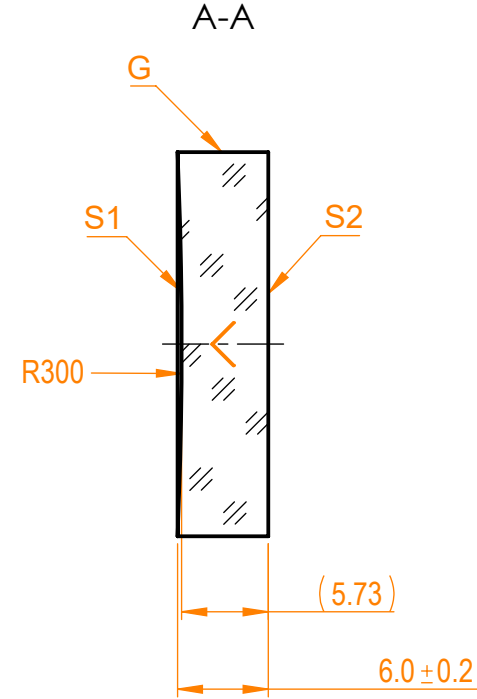

Isometric view 1:2

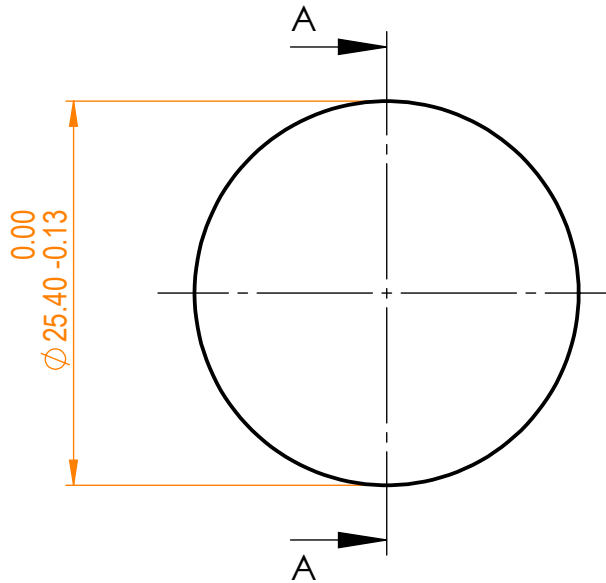

Specifications are subject to change without notice  
Dimensions are for reference only

Parameters

	S1	S2
Shape	Concave	Plano
Radius of curvature	300	Infinity
Surface flatness	$\lambda/10$ @633nm	$\lambda$ @633nm
Surface quality	40-20 s/d	80-50 s/d
Clear aperture	>90%	>90%
Coating	Protected gold Ravg>98%@900nm - IR	Uncoated



UVFS pl/cv mirror, D=25.4 mm, T=6 mm

Proprietary	Approved	Name	Date	Part number	Rev.	Scale
The information in this drawing is property of EKSMA Optics. Any reproduction in part or as a whole without the written permission of EKSMA Optics is prohibited.	Approved	A.K.	2020.11.16	092-3130R-300	A	2:1
	Drawn	V.S.	2020.11.16			