

NOTES:

1. Material: UVFS;
2. G - Fine ground surface;
3. All dimensions are in mm;
4. Wedge: <3 min;
5. Protective chamfers: 0.3 mm x 45°;
6. Group delay dispersion: <|5fs²|;
7. Laser Induced Damage Threshold: > 0.25 J/cm² at @800nm, 100Hz, 100fsec pulses;

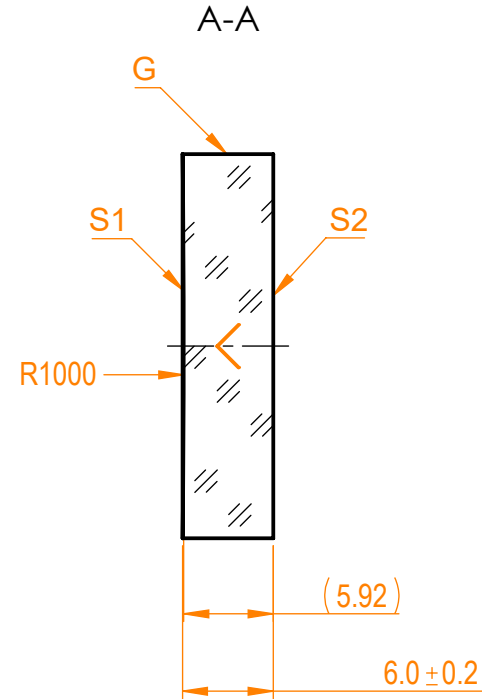

Isometric view 1:2



Specifications are subject to change without notice
Dimensions are for reference only

Parameters

	S1	S2
Shape	Concave	Plano
Radius of curvature	1000	Infinity
Surface flatness	λ/10 @633nm	λ @633nm
Surface quality	40-20 s/d	80-50 s/d
Clear aperture	>90%	>90%
Coating	Enhanced silver R>98.5% @600-1100nm, R>99% @700-900nm	Uncoated



UVFS pl/cv mirror, D=25.4 mm, T=6 mm

Proprietary	Approved	Name	Date	Part number	Rev.	Scale
The information in this drawing is property of EKSMA Optics. Any reproduction in part or as a whole without the written permission of EKSMA Optics is prohibited.	Drawn	A.K.	2020.11.16	092-3125FR-1000	A	2:1
		V.S.	2020.11.16			