

**NOTES:**

1. Material: N-BK7;
2. G - Fine ground surface;
3. All dimensions are in mm;
4. Wedge: <3 min;
5. Protective chamfers: 0.3 mm x 45°;
6. Laser Induced Damage Threshold:
  - > 0.25 J/cm<sup>2</sup> at @800nm, 50Hz, 94fsec pulses,
  - > 1.8 J/cm<sup>2</sup> at @1064nm, 50Hz, 11nsec pulses;

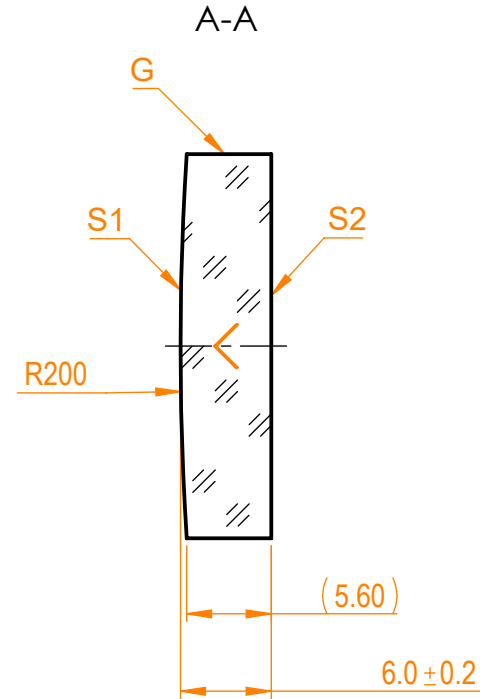

Isometric view 1:2

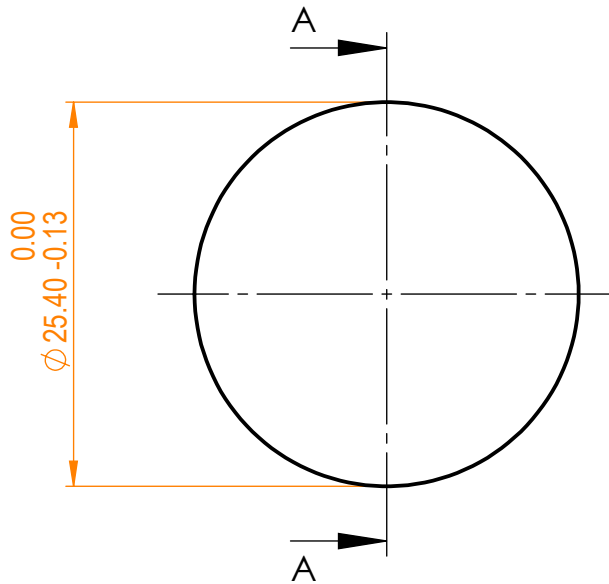

Specifications are subject to change without notice  
 Dimensions are for reference only

Parameters				 info@eksmaoptics.com www.eksmaoptics.com		N-BK7 pl/cx mirror, D=25.4 mm, T=6 mm				
	S1	S2								
Shape	Convex	Plano								
Radius of curvature	200	Infinity								
Surface flatness	λ/10 @633nm	λ @633nm								
Surface quality	40-20 s/d	80-50 s/d								
Clear aperture	>90%	>90%								
Coating	Protected silver Ravg>96%@400nm - IR	Uncoated								
				Proprietary		Name	Date	Part number	Rev.	Scale
				The information in this drawing is property of EKSMA Optics. Any reproduction in part or as a whole without the written permission of EKSMA Optics is prohibited.	Approved	A.K.	2020.11.16	092-0225R+200	A	2:1
					Drawn	V.S.	2020.11.16			