

NOTES:

1. Material: UVFS;
2. G - Fine ground surface;
3. All dimensions are in mm;
4. Wedge: <3 min;
5. Protective chamfers: 0.3 mm x 45°;
6. Laser Induced Damage Threshold:
 - > 0.1 J/cm² at @355nm, 50Hz, 5.7nsec pulses,
 - > 0.25 J/cm² at @1064nm, 50Hz, 11nsec pulses;

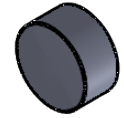

Isometric view 1:1

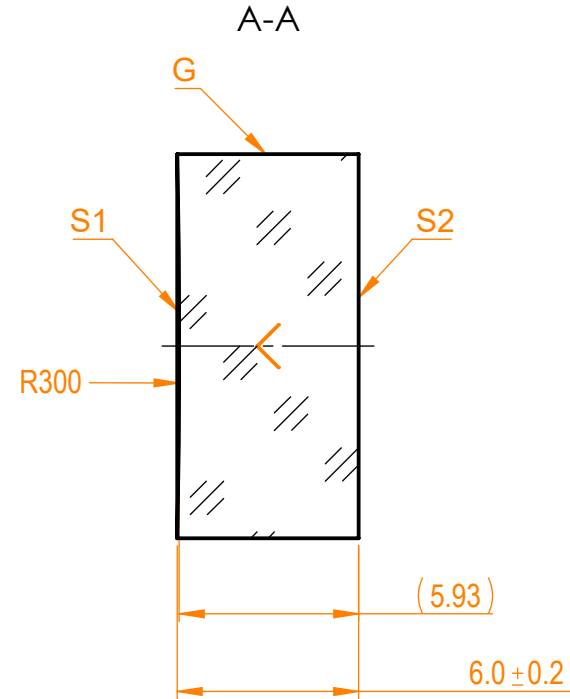
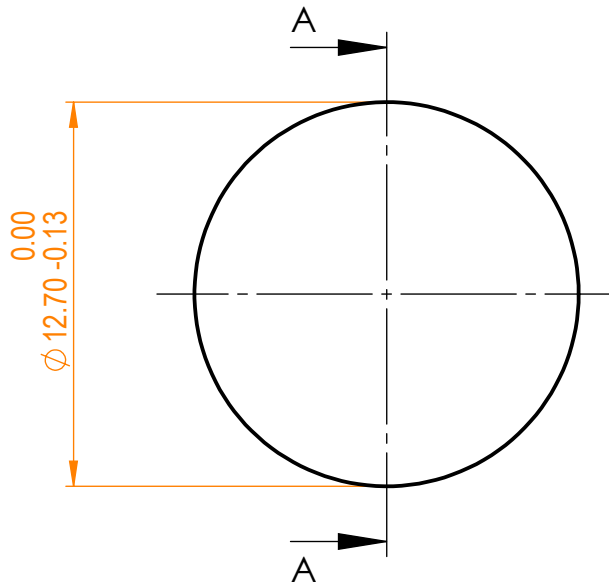

Specifications are subject to change without notice
Dimensions are for reference only

Parameters						UVFS pl/cv mirror, D=12.7 mm, T=6 mm					
	S1	S2									
Shape	Concave	Plano									
Radius of curvature	300	Infinity									
Surface flatness	$\lambda/10$ @633nm	λ @633nm									
Surface quality	40-20 s/d	80-50 s/d									
Clear aperture	>90%	>90%									
Coating	Protected aluminium Ravg>86%@300nm - IR	Uncoated									
				Proprietary The information in this drawing is property of EKSMA Optics. Any reproduction in part or as a whole without the written permission of EKSMA Optics is prohibited.		Approved Drawn	Name A.K. V.S.	Date 2020.11.16 2020.11.16	Part number 091-3115R-300	Rev. A	Scale 4:1