

NOTES:

1. Material: UVFS;
2. LDT: >100 mJ/cm², 50 fsec, 100Hz, 800 nm;
3. Coating adhesion and durability: MIL-C-675A;
4. Protective chamfers: 0.2 - 0.3 mm x 45°;
5. G - Fine ground surface;
6. All dimensions are in mm.

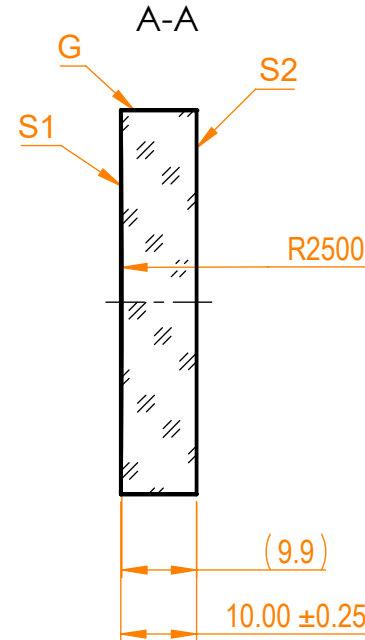

Isometric view 1:5

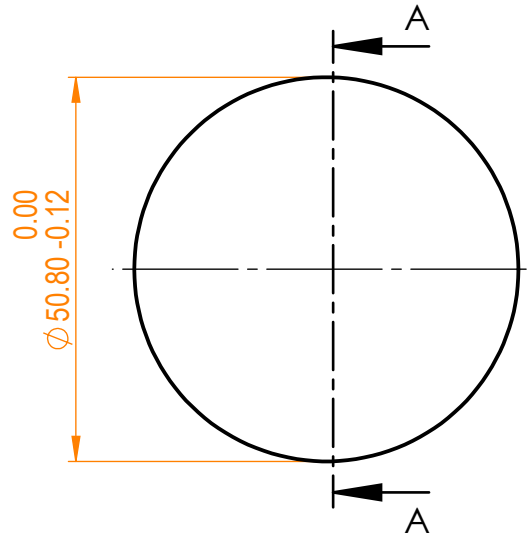

Parameters

	S1	S2
Shape	Concave	Plano
Radius of curvature	2500 mm	Infinity
Surface quality	20-10 s/d	Commercial polish
Surface irregularity	$\lambda/10$ @632.8 nm	-
Clear aperture	≥85%	-
Coating	HR>99.7% @800±20nm, AOI=0°	-



UVFS pl/cv mirror, D=50.8 mm

Proprietary	Approved	Name	Date	Part number	Rev.	Scale
The information in this drawing is property of EKSMA Optics. Any reproduction in part or as a whole without the written permission of EKSMA Optics is prohibited.	Drawn	A.K.	2020.12.22	085-8250	A	1:1
		M.B.	2020.12.22			