

NOTES:

1. Material: UVFS;
2. |GDD|: <math><30 \text{ fs}^2</math>, 720-880nm;
3. Wedge: <math><3 \text{ min}</math>;
4. LDT: >50 mJ/cm², 50 fsec, 100Hz, 800 nm;
5. G - Fine ground surface;
6. All dimensions are in mm;

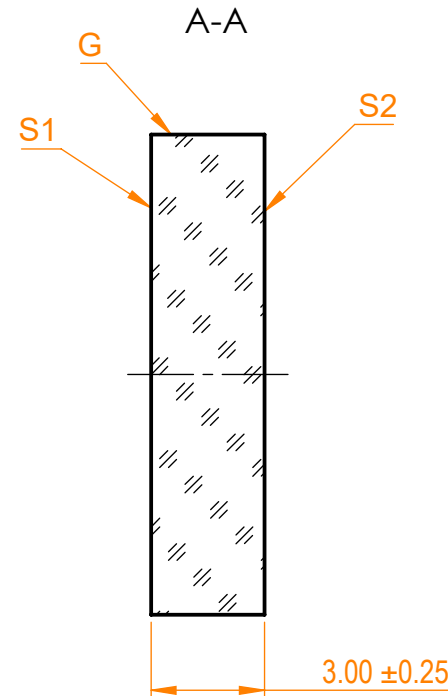

Isometric view 1:1



Specifications are subject to change without notice
 Dimensions are for reference only

Parameters		
	S1	S2
Shape	Plano	Plano
Surface quality	20-10 s/d	80-60 s/d
Surface flatness	$\lambda/10$ @632.8 nm	λ @632.8 nm
Protective chamfers	0.2 - 0.3 mm x 45°	0.2 - 0.3 mm x 45°
Clear aperture	≥90%	≥90%
Coating	HRavg>99% @720-880nm, AOI=0°	Uncoated



D=12.7 mm, Broadband Low GDD
 Ultrafast Mirror

Proprietary	Approved	Name	Date	Part number	Rev.	Scale
The information in this drawing is property of EKSMA Optics. Any reproduction in part or as a whole without the written permission of EKSMA Optics is prohibited.	Approved	A.K.	2020.11.05	081-7288-i0	A	5:1
	Drawn	M.B.	2020.11.05			