

NOTES:

1. Material: BK7;
2. LDT: >100 mJ/cm², 50 fsec, 100Hz, 800 nm;
3. Coating adhesion and durability: MIL-C-675A;
4. Protective chamfers: 0.2 - 0.3 mm x 45°;
5. G - Fine ground surface;
6. All dimensions are in mm.

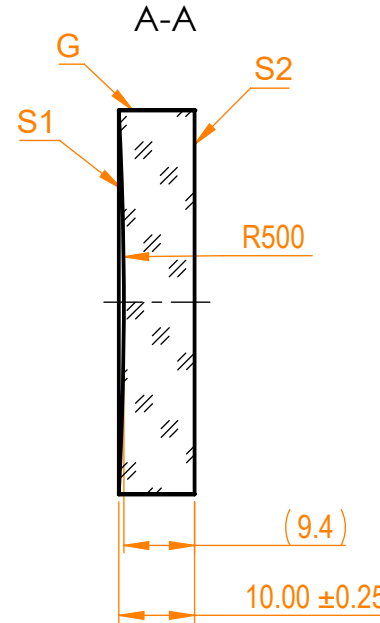

Isometric view 1:5

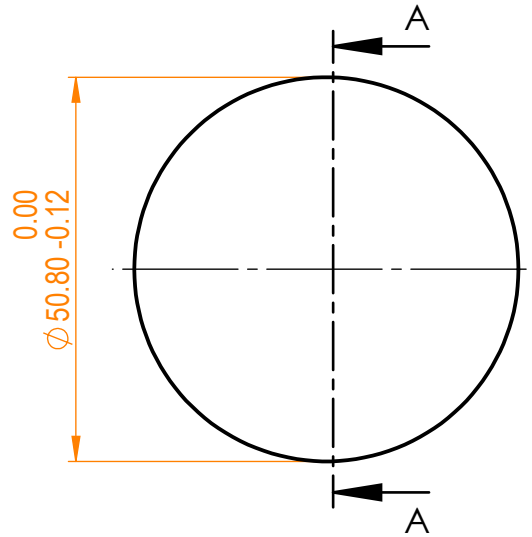

Parameters

| | S1 | S2 |
|----------------------|----------------------------|-------------------|
| Shape | Concave | Plano |
| Radius of curvature | 500 mm | Infinity |
| Surface quality | 20-10 s/d | Commercial polish |
| Surface irregularity | $\lambda/10$ @632.8 nm | - |
| Clear aperture | ≥85% | - |
| Coating | HR>99.7% @800±20nm, AOI=0° | - |



N-BK7 pl/cv mirror, D=50.8 mm

| Proprietary | Approved | Name | Date | Part number | Rev. | Scale |
|---|----------|------|------------|-------------|------|-------|
| The information in this drawing is property of EKSMA Optics. Any reproduction in part or as a whole without the written permission of EKSMA Optics is prohibited. | Drawn | A.K. | 2020.12.22 | 065-8050 | A | 1:1 |
| | | M.B. | 2020.12.22 | | | |