

NOTES:
 1. Material: UVFS;
 2. G - Fine ground surface;
 3. All dimensions are in mm;

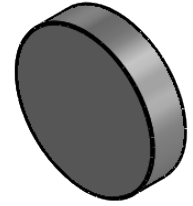

Isometric view 1:1

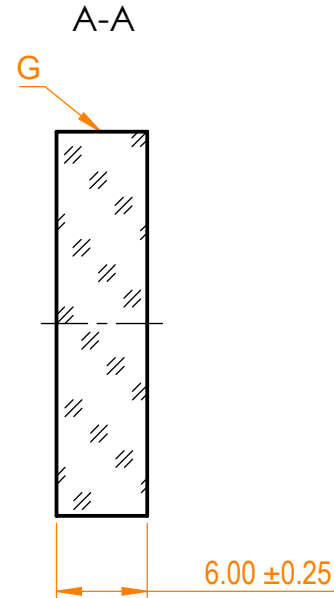
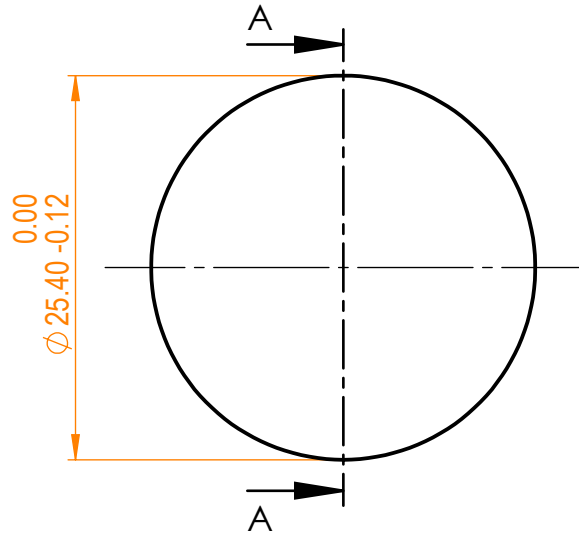

Specifications are subject to change without notice
 Dimensions are for reference only

Parameters	
Shape	Plano
S1 Surface flatness	$\lambda/10$ @632.8 nm
S1 Surface quality	20-10 s/d
S2 Surface quality	Commercial polish
Clear aperture	$\geq 85\%$
Protective chamfers	0.2 - 0.3 mm x 45°
Wedge	<3 minutes
Coating	HR _{(s+p)/2} >99.5%@266+355nm, AOI=0°



UVFS pl mirror, D=25.4 mm, T=6 mm

Proprietary	Approved	Name	Date	Part number	Rev.	Scale
The information in this drawing is property of EKSMA Optics. Any reproduction in part or as a whole without the written permission of EKSMA Optics is prohibited.	Drawn	A.K.	2019.12.19	062-2635-i0	A	2:1
		A.F.	2019.12.19			