

NOTES:
 1. Material: BK7;
 2. G - Fine ground surface;
 3. All dimensions are in mm;

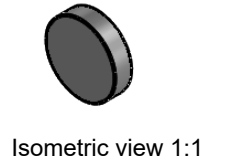
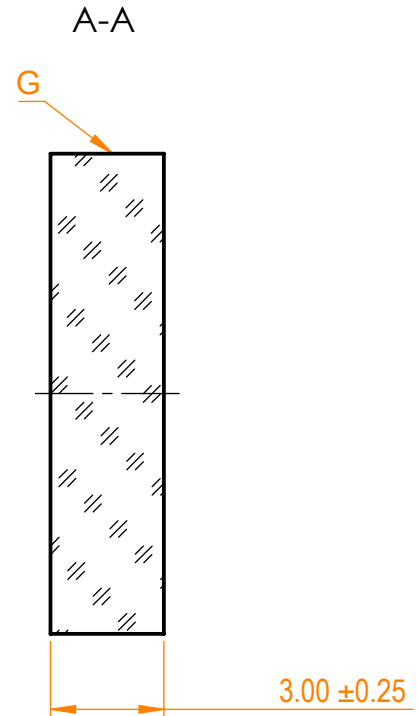
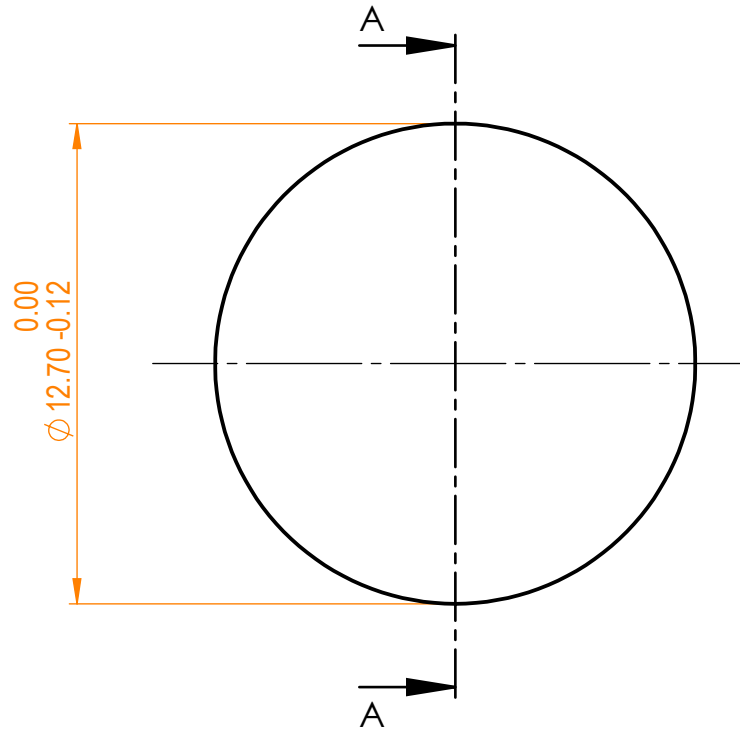

Specifications are subject to change without notice
 Dimensions are for reference only

Parameters	
Shape	Plano
S1 Surface flatness	$\lambda/10$ @632.8 nm
S1 Surface quality	20-10 s/d
S2 Surface quality	Commercial polish
Clear aperture	$\geq 85\%$
Protective chamfers	0.2 - 0.3 mm x 45°
Wedge	<3 minutes
Coating	HR _{(s+p)/2} >99.5% @390-410+780-820nm, AOI=0°

 info@eksmaoptics.com www.eksmaoptics.com		BK7 pl mirror, D=12.7 mm, T=3 mm					
						Proprietary	
The information in this drawing is property of EKSMA Optics. Any reproduction in part or as a whole without the written permission of EKSMA Optics is prohibited.		Approved	A.K.	2019.12.19	051-4080-i0	A	5:1
		Drawn	A.F.	2019.12.19			