

NOTES:

1. Material: UVFS;
2. Wedge: <30 arcsec;
3. LDT: >100 mJ/cm², 50 fsec, 100Hz, 800 nm;
4. Coating adhesion and durability: MIL-C-675A;
5. Protective chamfers: 0.2 - 0.3 mm x 45°;
6. G - Fine ground surface;
7. All dimensions are in mm;

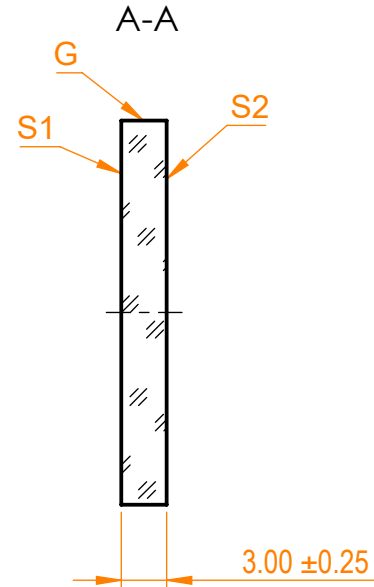
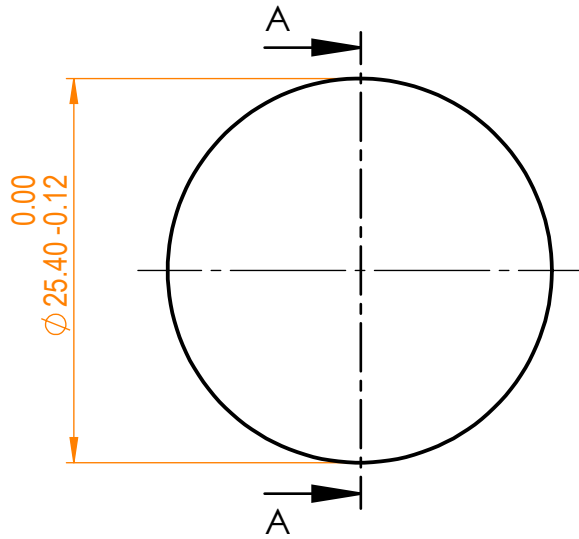
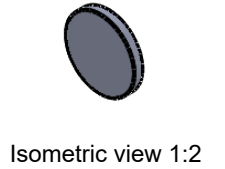

Specifications are subject to change without notice
 Dimensions are for reference only

Parameters		
	S1	S2
Shape	Plano	Plano
Surface quality	20-10 s/d	20-10 s/d
Surface flatness	$\lambda/10$ @632.8 nm	$\lambda/10$ @632.8 nm
Clear aperture	≥85%	≥85%
Coating	R>99%@257-275nm + T<95%@780-820nm, AOI=0°, Low GDD	AR<0.25%@780-820nm, AOI=0°



D=25.4 mm, Femtoline Harmonic Separator

Proprietary	Name	Date	Part number	Rev.	Scale
The information in this drawing is property of EKSMA Optics. Any reproduction in part or as a whole without the written permission of EKSMA Optics is prohibited.	Approved	A.K.	2021.01.11	042-2800	A
	Drawn	M.B.	2021.01.11		