

NOTES:

1. Material: UVFS;
2. Wedge: <30 arcsec;
3. LDT: >20 mJ/cm², 50 fsec, 100Hz, 266 nm;
4. Coating adhesion and durability: MIL-C-675A;
5. G - Fine ground surface;
6. All dimensions are in mm;

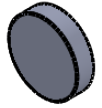

Isometric view 1:1

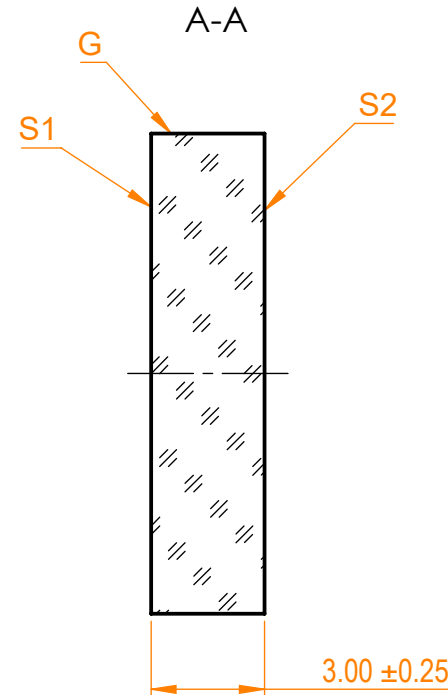
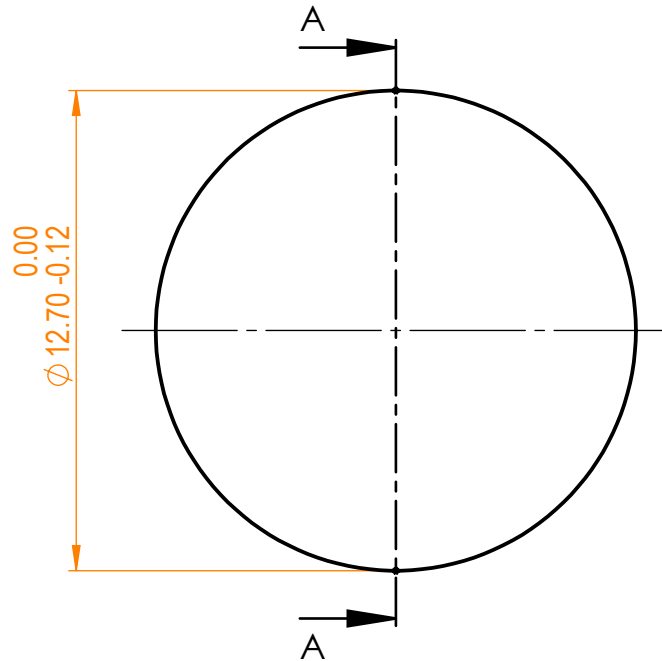

Specifications are subject to change without notice
Dimensions are for reference only

Parameters		
	S1	S2
Shape	Plano	Plano
Surface quality	20-10 s/d	20-10 s/d
Surface flatness	$\lambda/10$ @632.8 nm	$\lambda/10$ @632.8 nm
Protective chamfers	0.2 - 0.3 mm x 45°	0.2 - 0.3 mm x 45°
Clear aperture	≥85%	≥85%
Coating	Rs=30±3%@266nm, AOI=45°, Low GDD	ARs<0.5%@266nm, AOI=45°



D=12.7 mm, Femtoline Laser Beamsplitter

Proprietary		Name	Date	Part number	Rev.	Scale
The information in this drawing is property of EKSMA Optics. Any reproduction in part or as a whole without the written permission of EKSMA Optics is prohibited.	Approved	A.K.	2020.12.22	041-7930S	A	5:1
	Drawn	M.B.	2020.12.22			