

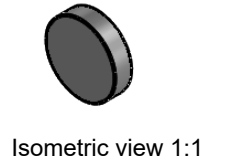

NOTES:
 1. Material: UVFS;
 2. G - Fine ground surface;
 3. All dimensions are in mm;

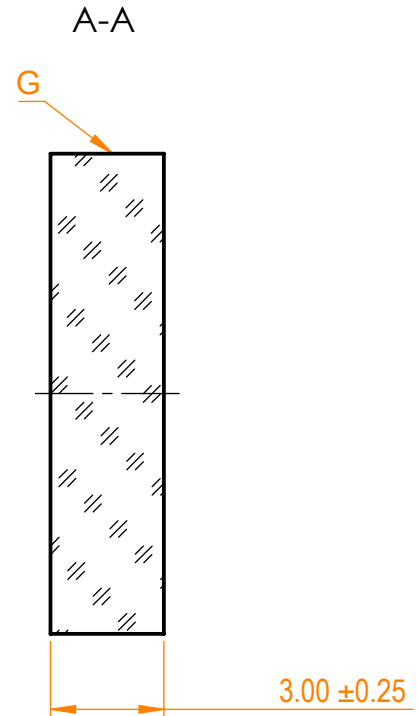
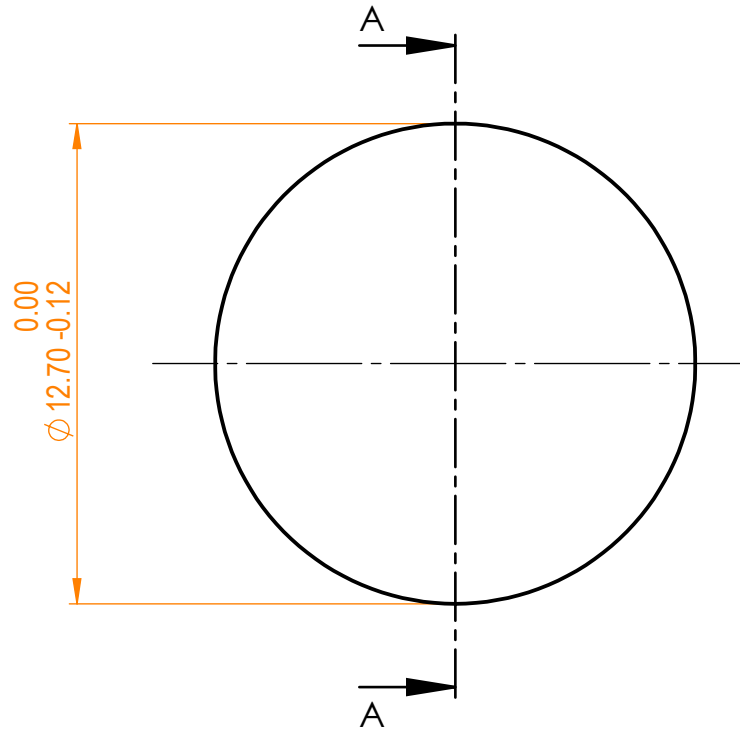

Specifications are subject to change without notice
 Dimensions are for reference only

Parameters	
Shape	Plano
S1 Surface flatness	$\lambda/10$ @632.8 nm
S1 Surface quality	20-10 s/d
S2 Surface quality	Commercial polish
Clear aperture	$\geq 85\%$
Protective chamfers	0.2 - 0.3 mm x 45°
Wedge	<3 minutes
Coating	HR _{(s+p)/2} >99.5%@500-530nm, AOI=45°



info@eksmaoptics.com
www.eksmaoptics.com

UVFS pl mirror, D=12.7 mm, T=3 mm

Proprietary		Name	Date	Part number	Rev.	Scale
The information in this drawing is property of EKSMA Optics. Any reproduction in part or as a whole without the written permission of EKSMA Optics is prohibited.	Approved	A.K.	2019.12.12	041-0515	A	5:1
	Drawn	A.F.	2019.12.12			