

NOTES:

1. Material: N-BK7;
2. G - Fine ground surface;
3. All dimensions are in mm;
4. Parallelism: <30 arcsec;
5. Protective chamfers: 0.3 mm x 45°;
6. Laser Induced Damage Threshold: >2 J/cm² at @1064nm, 10Hz, 8nsec pulses;

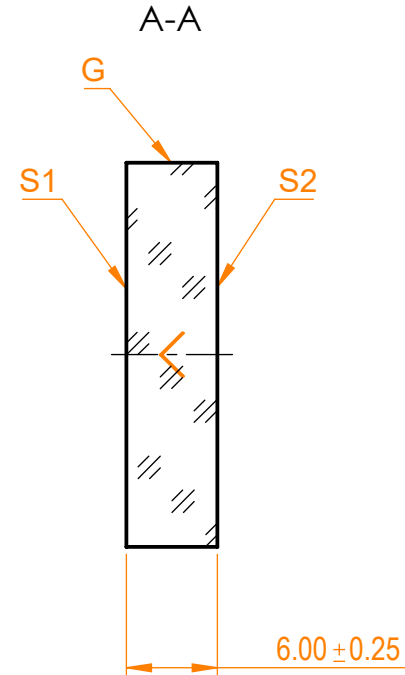

Isometric view 1:2

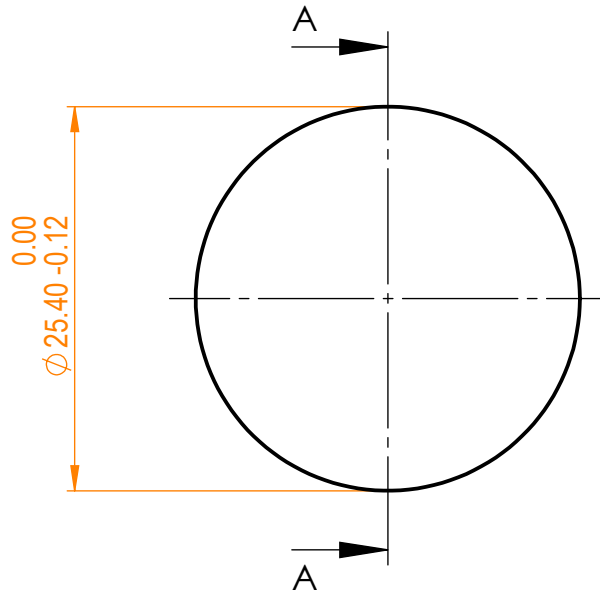

Specifications are subject to change without notice
Dimensions are for reference only

Parameters		S1	S2	 info@eksmaoptics.com www.eksmaoptics.com		N-BK7 pl mirror, D=25.4 mm, T=6 mm				
Shape	Plano	Plano	Plano			Proprietary	Name	Date	Part number	Rev.
Radius of curvature	Infinity	Infinity	Infinity	The information in this drawing is property of EKSMA Optics. Any reproduction in part or as a whole without the written permission of EKSMA Optics is prohibited.	Approved	A.K.	2020.09.11	032-6805	A	2:1
Surface flatness	$\lambda/10$ @633nm	$\lambda/10$ @633nm	$\lambda/10$ @633nm		Drawn	V.S.	2020.09.11			
Surface quality	20-10 s/d	20-10 s/d	20-10 s/d							
Clear aperture	≥85%	≥85%	≥85%							
Coating	HR _{(s+p)/2} >99.5%@1064nm, HT _{(s+p)/2} >95%@808nm, AOI=45°	AR<0.5%@1064nm, AOI=45°	AR<0.5%@1064nm, AOI=45°							