

NOTES:
 1. Material: BK7;
 2. G - Fine ground surface;
 3. All dimensions are in mm;

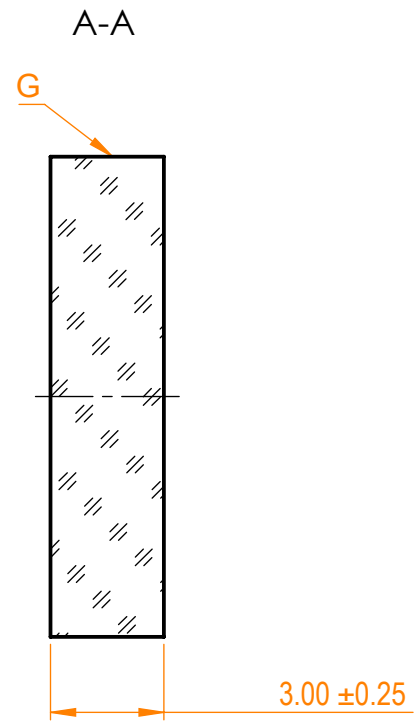

Isometric view 1:1

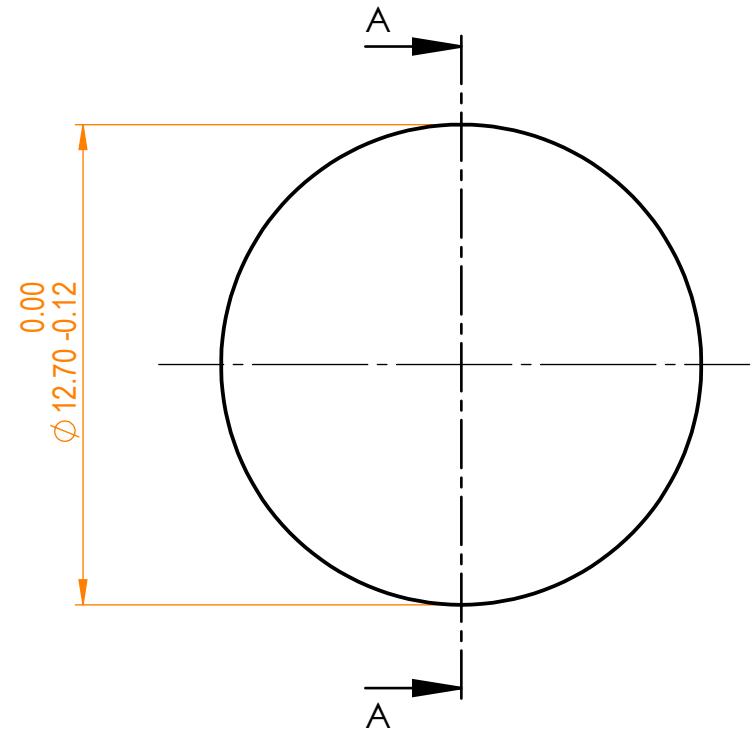

Specifications are subject to change without notice
 Dimensions are for reference only

Parameters		EKSMA OPTICS		BK7 pl mirror, D=12.7 mm, T=3 mm					
Shape	Plano	 info@eksmaoptics.com www.eksmaoptics.com		Name	Date	Part number	Rev.	Scale	
S1 Surface flatness	$\lambda/10$ @632.8 nm								
S1 Surface quality	20-10 s/d			Approved	A.K.	2019.12.12	031-0490	A	5:1
S2 Surface quality	Commercial polish								
Clear aperture	$\geq 85\%$			Drawn	A.F.	2019.12.12			
Protective chamfers	0.2 - 0.3 mm x 45°								
Wedge	<3 minutes			The information in this drawing is property of EKSMA Optics. Any reproduction in part or as a whole without the written permission of EKSMA Optics is prohibited.					
Coating	HR _{(s+p)/2} >99.5%@488-515nm, AOI=45°								