

NOTES:

1. Material: N-BK7;
2. G - Fine ground surface;
3. All dimensions are in mm;
4. Centration error: ≤ 3 arcmin;
5. Protective chamfers: 0.3 mm x 45°;
6. Radius tolerance: $\pm 1\%$;

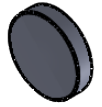

Isometric view 1:4

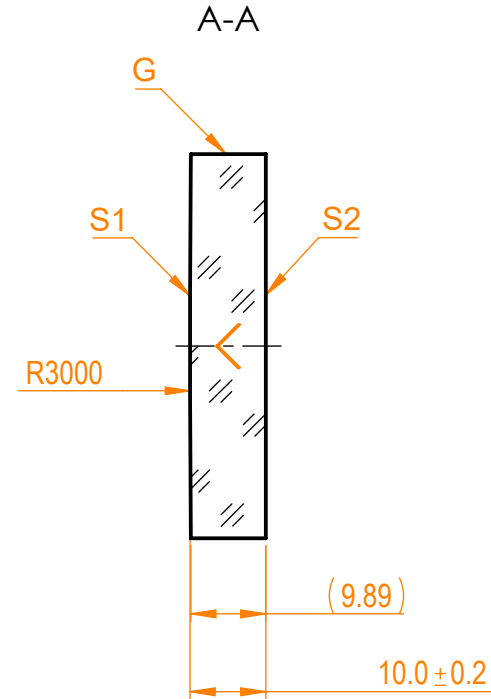
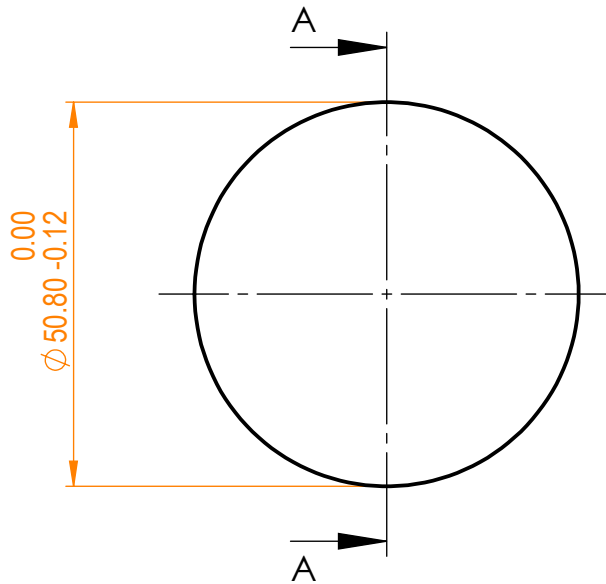

Specifications are subject to change without notice
Dimensions are for reference only

Parameters				 info@eksmaoptics.com www.eksmaoptics.com		N-BK7 pl/cx window, D=50.8 mm, T=10 mm				
	S1	S2								
Shape	Convex	Plano		Proprietary		Name	Date	Part number	Rev.	Scale
Radius of curvature	3000	Infinity		The information in this drawing is property of EKSMA Optics. Any reproduction in part or as a whole without the written permission of EKSMA Optics is prohibited.	Approved	A.K.	2020.11.16	011-0522E	A	1:1
Surface irregularity	$\lambda/10$ @633nm	$\lambda/10$ @633nm per inch			Drawn	V.S.	2020.11.16			
Surface quality	20-10 s/d	20-10 s/d								
Clear aperture	$\geq 90\%$	$\geq 90\%$								
Coating	-	-								