

NOTES:

1. Material: N-BK7;
2. G - Fine ground surface;
3. All dimensions are in mm;
4. Centration error: ≤ 3 arcmin;
5. Protective chamfers: 0.3 mm x 45°;
6. Radius tolerance: $\pm 1\%$;

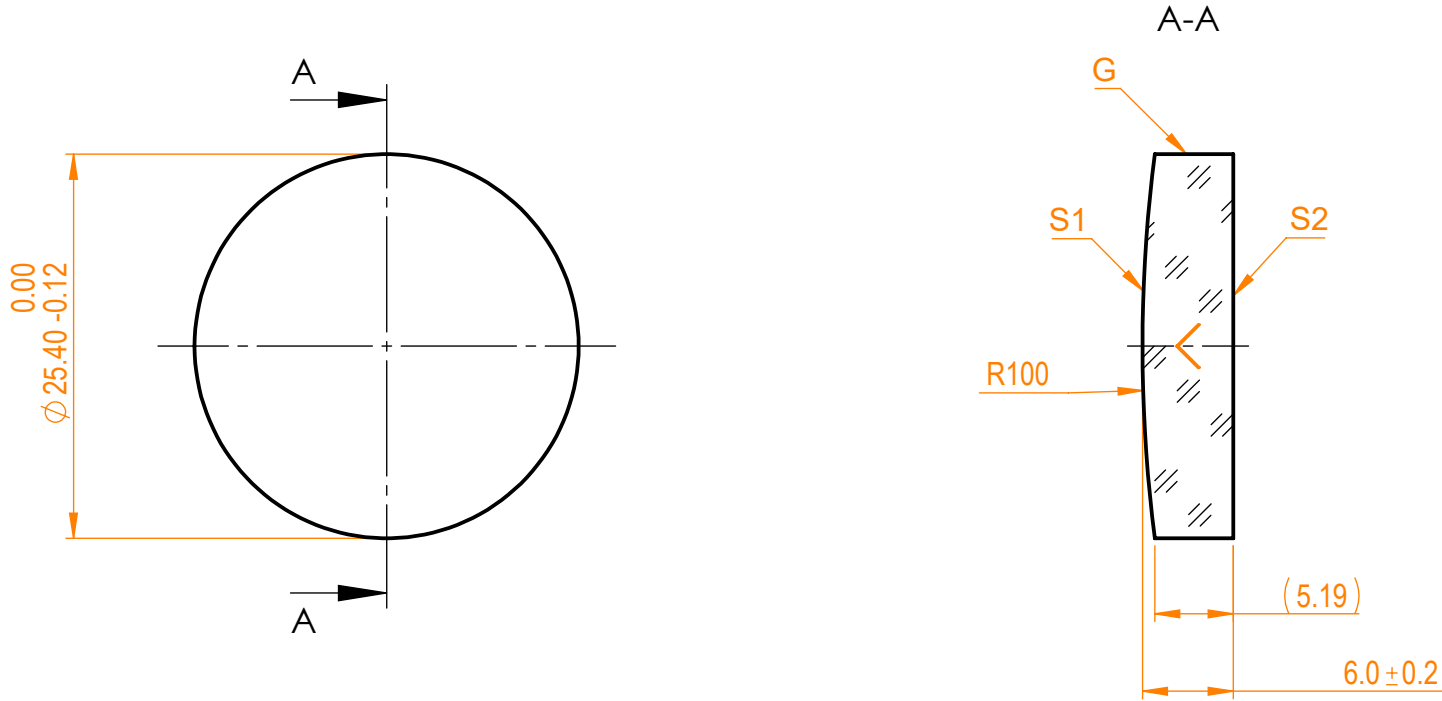

Isometric view 1:2



Specifications are subject to change without notice
Dimensions are for reference only

Parameters

	S1	S2
Shape	Convex	Plano
Radius of curvature	100	Infinity
Surface irregularity	$\lambda/10$ @633nm	$\lambda/10$ @633nm
Surface quality	20-10 s/d	20-10 s/d
Clear aperture	$\geq 90\%$	$\geq 90\%$
Coating	-	-



N-BK7 pl/cx window, D=25.4 mm, T=6 mm

Proprietary	Approved	Name	Date	Part number	Rev.	Scale
The information in this drawing is property of EKSMA Optics. Any reproduction in part or as a whole without the written permission of EKSMA Optics is prohibited.	Approved	A.K.	2020.11.16	011-0202E	A	2:1
	Drawn	V.S.	2020.11.16			