

**NOTES:**

1. Material: UVFS;
2. G - Fine ground surface;
3. All dimensions are in mm;
4. Centration error:  $\leq 3$  arcmin;
5. Protective chamfers: 0.3 mm x 45°;
6. Radius tolerance:  $\pm 1\%$ ;

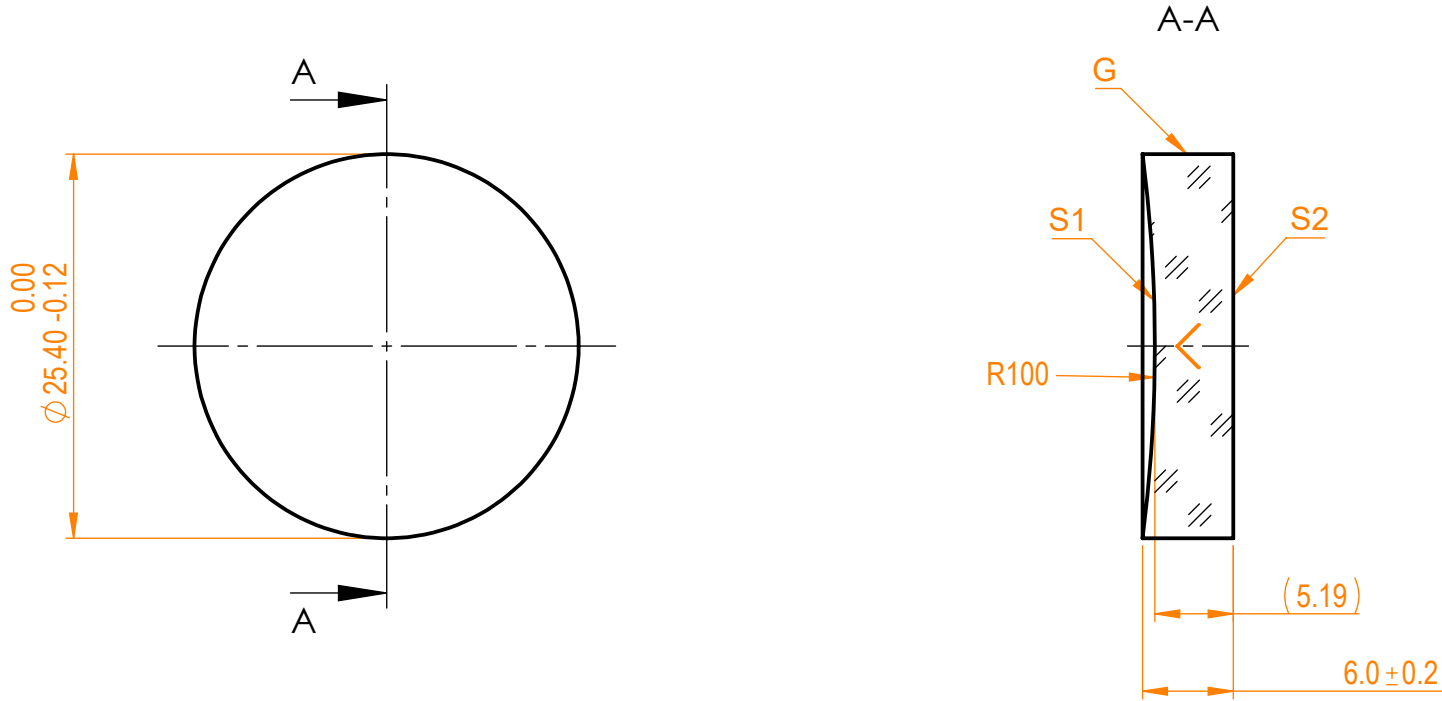

Isometric view 1:2



Specifications are subject to change without notice  
Dimensions are for reference only

Parameters				 info@eksmaoptics.com www.eksmaoptics.com		UVFS pl/cv window, D=25.4 mm, T=6 mm				
	S1	S2								
Shape	Concave	Plano								
Radius of curvature	100	Infinity								
Surface irregularity	$\lambda/10$ @633nm	$\lambda/10$ @633nm								
Surface quality	20-10 s/d	20-10 s/d								
Clear aperture	$\geq 90\%$	$\geq 90\%$								
Coating	-	-								
				Proprietary The information in this drawing is property of EKSMA Optics. Any reproduction in part or as a whole without the written permission of EKSMA Optics is prohibited.		Name A.K.	Date 2020.11.16	Part number 010-1202E	Rev. A	Scale 2:1
1	2	3	4	5	6					