

NOTES:

1. Material: N-BK7;
2. G - Fine ground surface;
3. All dimensions are in mm;
4. Centration error: ≤ 3 arcmin;
5. Protective chamfers: 0.3 mm x 45°;
6. Radius tolerance: $\pm 1\%$;

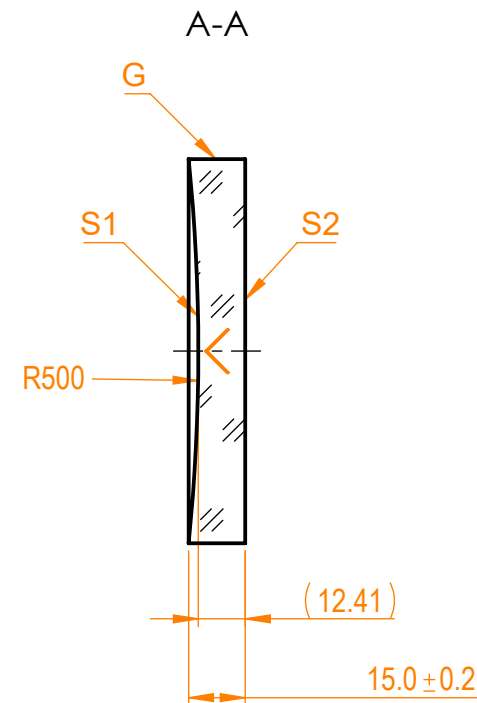

Isometric view 1:8

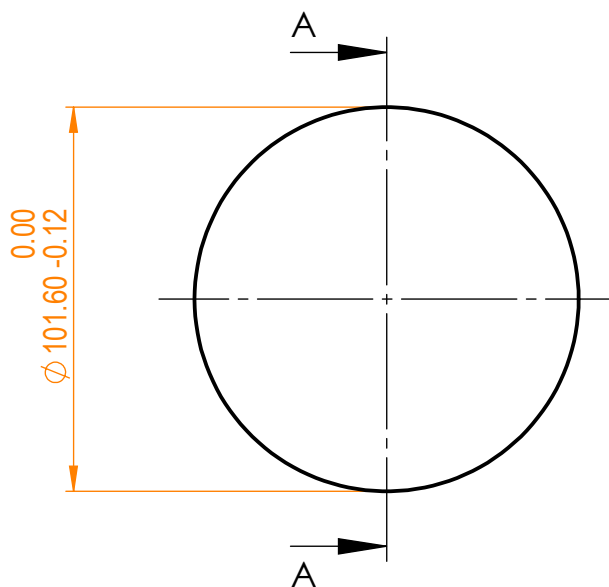

Specifications are subject to change without notice
Dimensions are for reference only

		Parameters		 info@eksmaoptics.com www.eksmaoptics.com		N-BK7 pl/cv window, D=101.6 mm, T=15 mm				
		S1	S2			Name	Date	Part number	Rev.	Scale
Shape		Concave	Plano	Proprietary The information in this drawing is property of EKSMA Optics. Any reproduction in part or as a whole without the written permission of EKSMA Optics is prohibited.	Approved	A.K.	2020.11.16	010-0812E	A	1:2
Radius of curvature		500	Infinity							
Surface irregularity		$\lambda/10$ @633nm	$\lambda/10$ @633nm							
Surface quality		20-10 s/d	20-10 s/d							
Clear aperture		$\geq 90\%$	$\geq 90\%$							
Coating		-	-							