

NOTES:

1. Material: N-BK7;
2. G - Fine ground surface;
3. All dimensions are in mm;
4. Centration error: ≤ 3 arcmin;
5. Protective chamfers: 0.3 mm x 45°;
6. Radius tolerance: $\pm 1\%$;

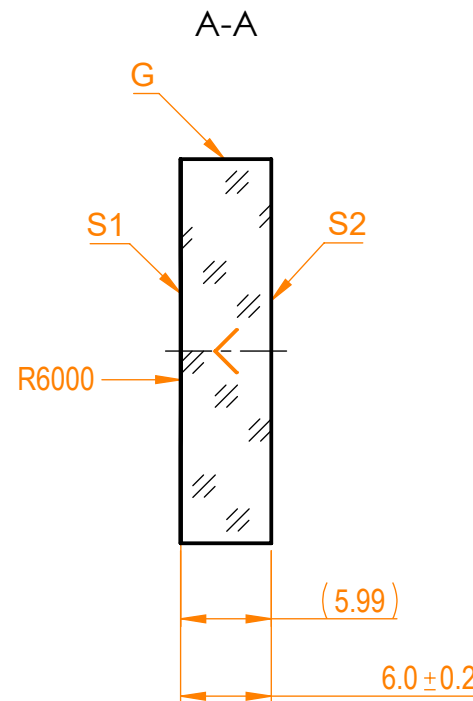

Isometric view 1:2

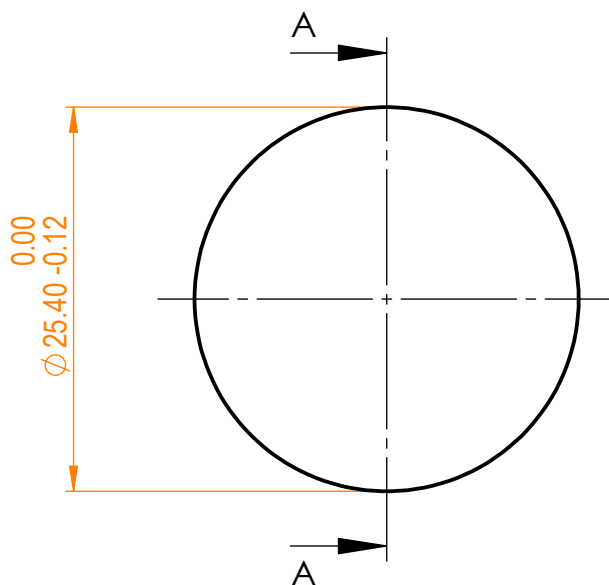

Specifications are subject to change without notice
Dimensions are for reference only

| Parameters | | | |  info@eksmaoptics.com www.eksmaoptics.com | | N-BK7 pl/cv window, D=25.4 mm, T=6 mm | | | | |
|----------------------|---------------------|---------------------|--|--|--|---------------------------------------|--|--|--|--|
| | S1 | S2 | | | | | | | | |
| Shape | Concave | Plano | | | | | | | | |
| Radius of curvature | 6000 | Infinity | | | | | | | | |
| Surface irregularity | $\lambda/10$ @633nm | $\lambda/10$ @633nm | | | | | | | | |
| Surface quality | 20-10 s/d | 20-10 s/d | | | | | | | | |
| Clear aperture | $\geq 90\%$ | $\geq 90\%$ | | | | | | | | |
| Coating | - | - | | | | | | | | |
| | | | | | | | | | | |

| Proprietary | Approved | Name | Date | Part number | Rev. | Scale |
|---|----------|------|------------|-------------|------|-------|
| The information in this drawing is property of EKSMA Optics. Any reproduction in part or as a whole without the written permission of EKSMA Optics is prohibited. | Approved | A.K. | 2020.11.16 | 010-0235E | A | 2:1 |
| | Drawn | V.S. | 2020.11.16 | | | |