

NOTES:

- 1. Material: N-BK7;
- 2. G - Fine ground surface;
- 3. All dimensions are in mm;
- 4. Centration error: ≤ 3 arcmin;
- 5. Protective chamfers: 0.3 mm x 45°;
- 6. Radius tolerance: $\pm 1\%$;

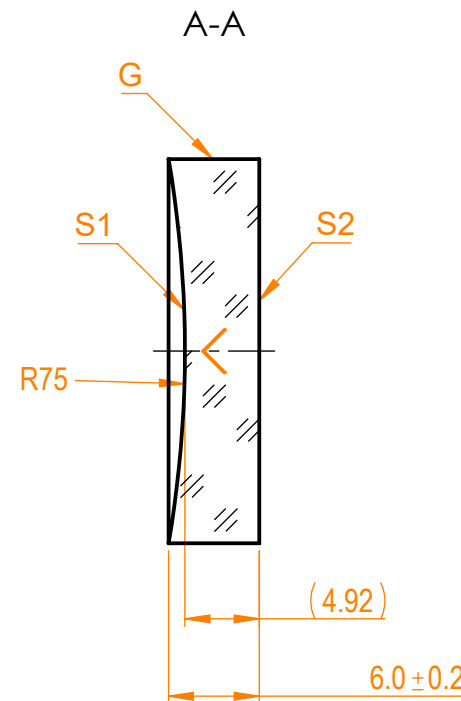

Isometric view 1:2

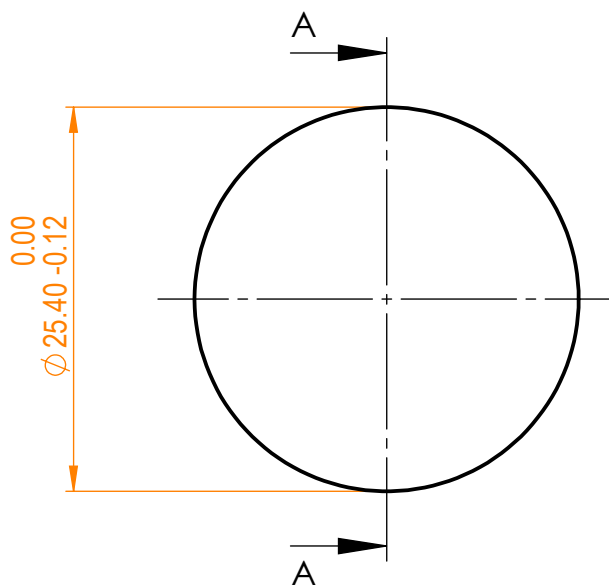

Specifications are subject to change without notice
Dimensions are for reference only

Parameters				 info@eksmaoptics.com www.eksmaoptics.com		N-BK7 pl/cv window, D=25.4 mm, T=6 mm				
	S1	S2								
Shape	Concave	Plano								
Radius of curvature	75	Infinity								
Surface irregularity	$\lambda/10$ @633nm	$\lambda/10$ @633nm								
Surface quality	20-10 s/d	20-10 s/d								
Clear aperture	$\geq 90\%$	$\geq 90\%$								
Coating	-	-								
				Proprietary		Name	Date	Part number	Rev.	Scale
				The information in this drawing is property of EKSMA Optics. Any reproduction in part or as a whole without the written permission of EKSMA Optics is prohibited.	Approved	A.K.	2020.11.16	010-0207E	A	2:1
					Drawn	V.S.	2020.11.16			