

NOTES:

1. Material: N-BK7;
2. G - Fine ground surface;
3. All dimensions are in mm;
4. Centration error: ≤ 3 arcmin;
5. Protective chamfers: 0.3 mm x 45°;
6. Radius tolerance: $\pm 1\%$;

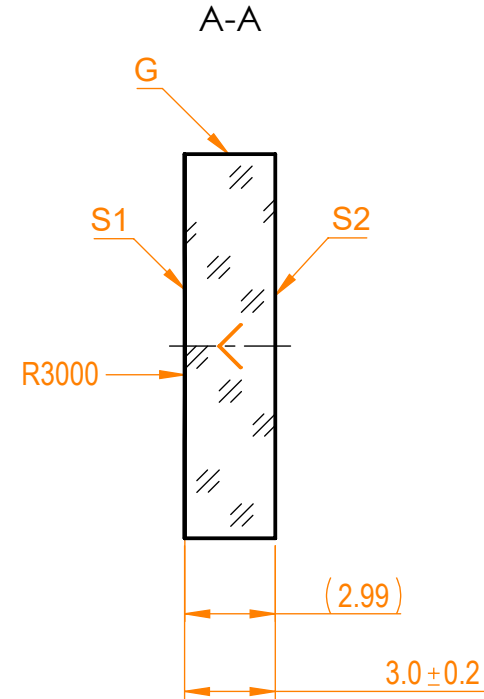

Isometric view 1:1

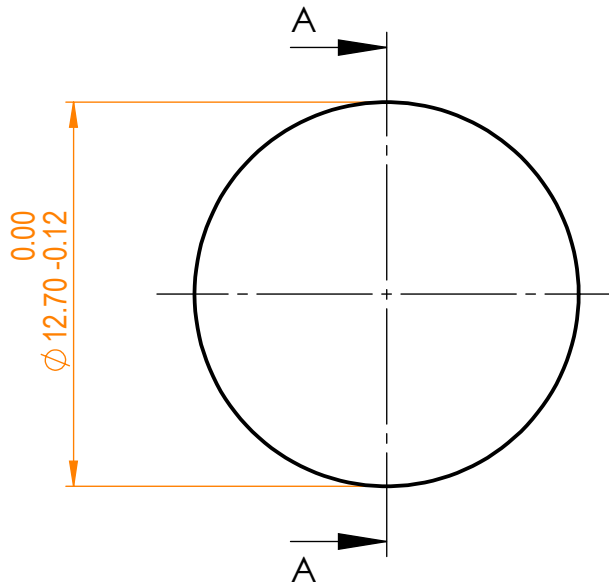

Specifications are subject to change without notice
Dimensions are for reference only

Parameters				 info@eksmaoptics.com www.eksmaoptics.com		N-BK7 pl/cv window, D=12.7 mm, T=3 mm				
	S1	S2								
Shape	Concave	Plano								
Radius of curvature	3000	Infinity								
Surface irregularity	$\lambda/10$ @633nm	$\lambda/10$ @633nm								
Surface quality	20-10 s/d	20-10 s/d								
Clear aperture	$\geq 90\%$	$\geq 90\%$								
Coating	-	-								
				Proprietary		Name	Date	Part number	Rev.	Scale
				The information in this drawing is property of EKSMA Optics. Any reproduction in part or as a whole without the written permission of EKSMA Optics is prohibited.	Approved	A.K.	2020.11.16	010-0130E	A	4:1
					Drawn	V.S.	2020.11.16			